

# Status of the CLIC project



**Aleksander Filip Żarnecki**  
Faculty of Physics, University of Warsaw

NA61/SHINE collaboration meeting  
13 February 2019



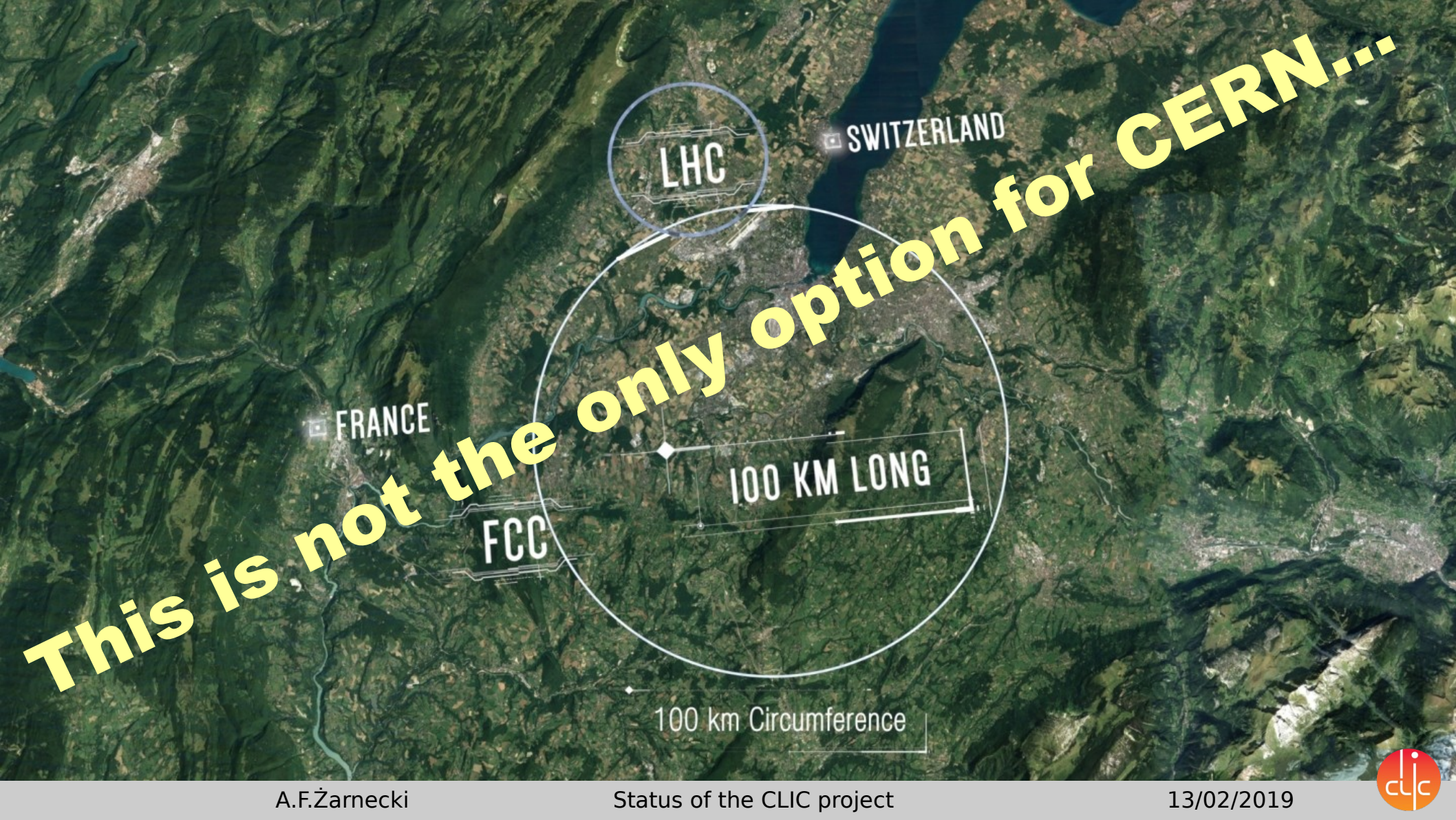

**This is not the only option for CERN...**

LHC

SWITZERLAND

FRANCE

FCC

100 KM LONG

100 km Circumference



# Compact Linear Collider (CLIC)

-  380 GeV - 11.4 km (CLIC380)
-  1.5 TeV - 29.0 km (CLIC1500)
-  3.0 TeV - 50.1 km (CLIC3000)

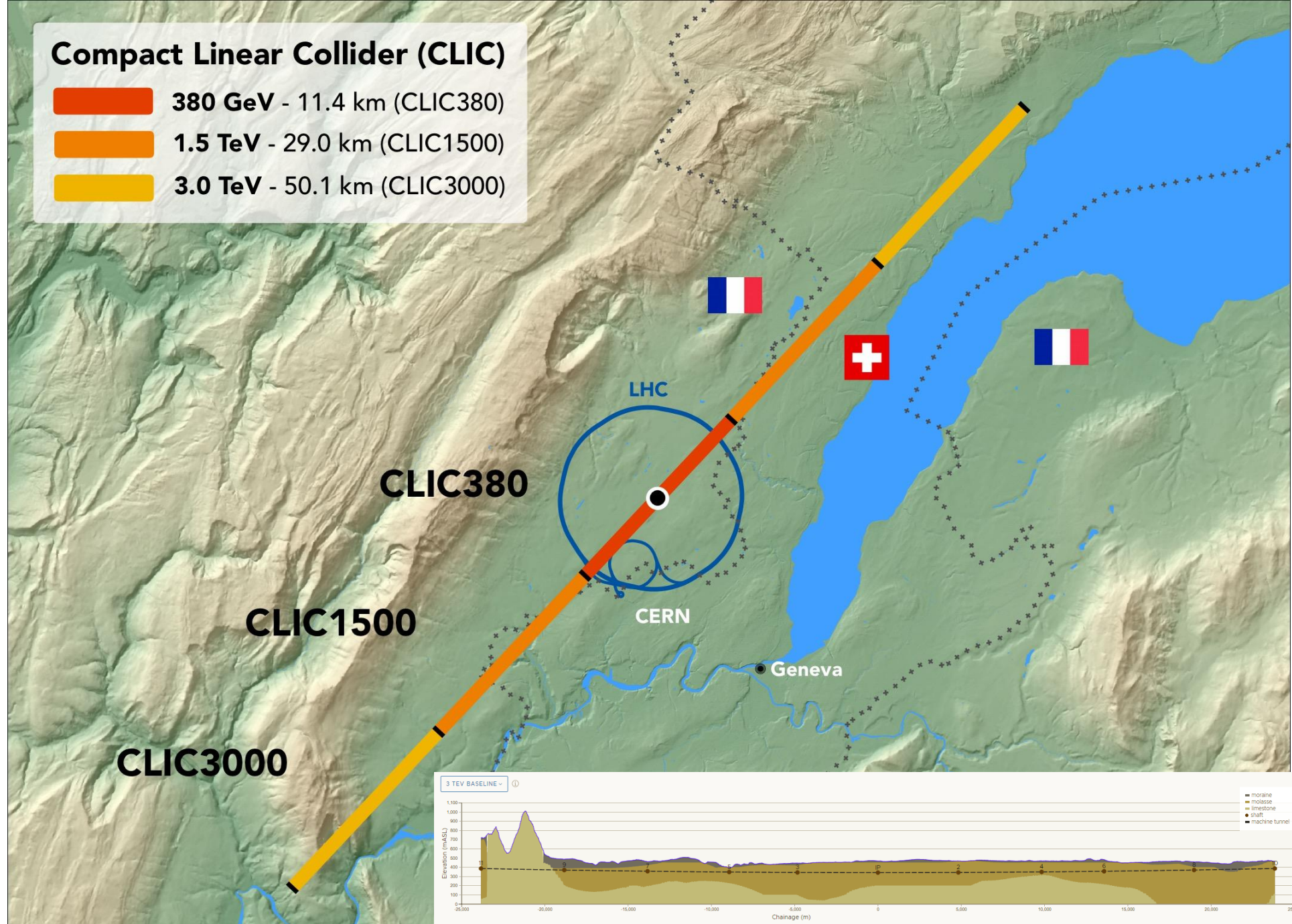



# Collaborations

<http://clic.cern/>



CLIC accelerator collaboration  
53 institutes from 31 countries

CLIC detector and physics (CLICdp)  
30 institutes from 18 countries

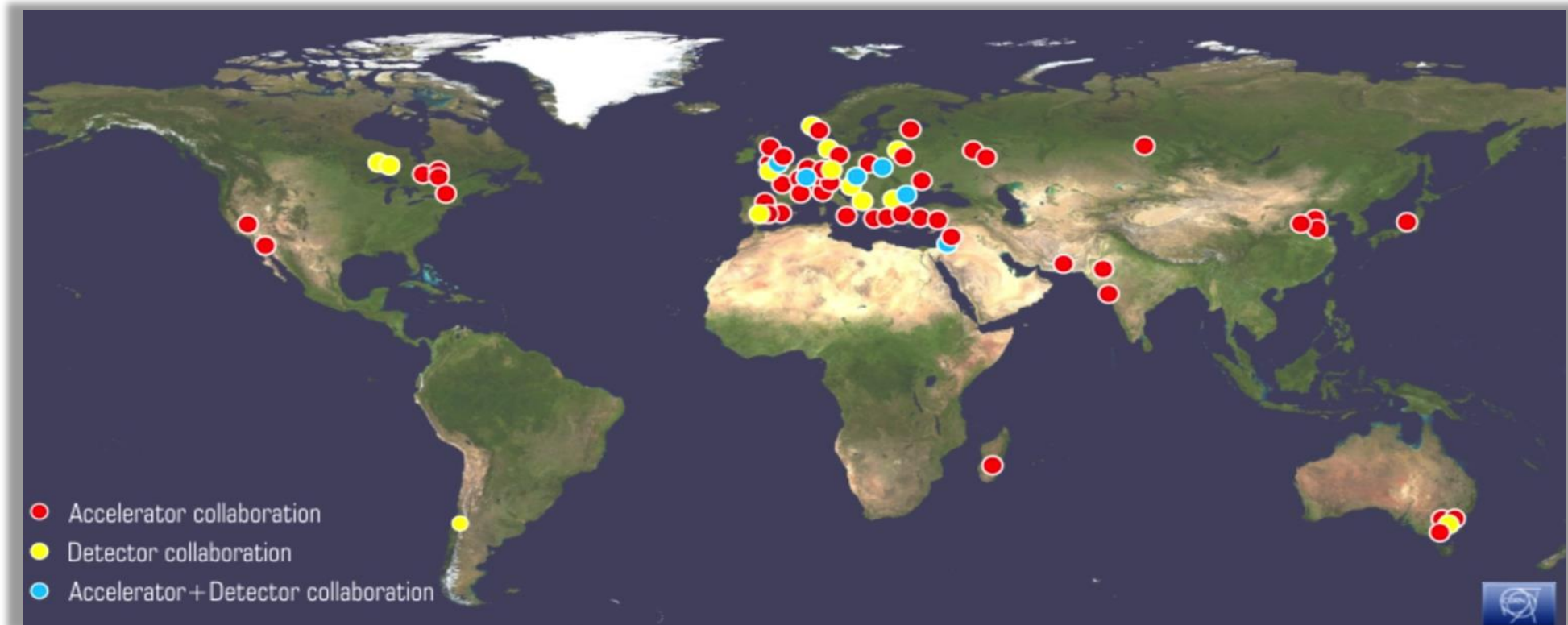

# Status of the CLIC project



Based on the reports presented at **CLIC Week 2019**  
and **CLICdp presentations at ICHEP'2018**



# Outline

- Accelerator design
- Detector concept
- Physics Program
- Status of the project



# Accelerator design

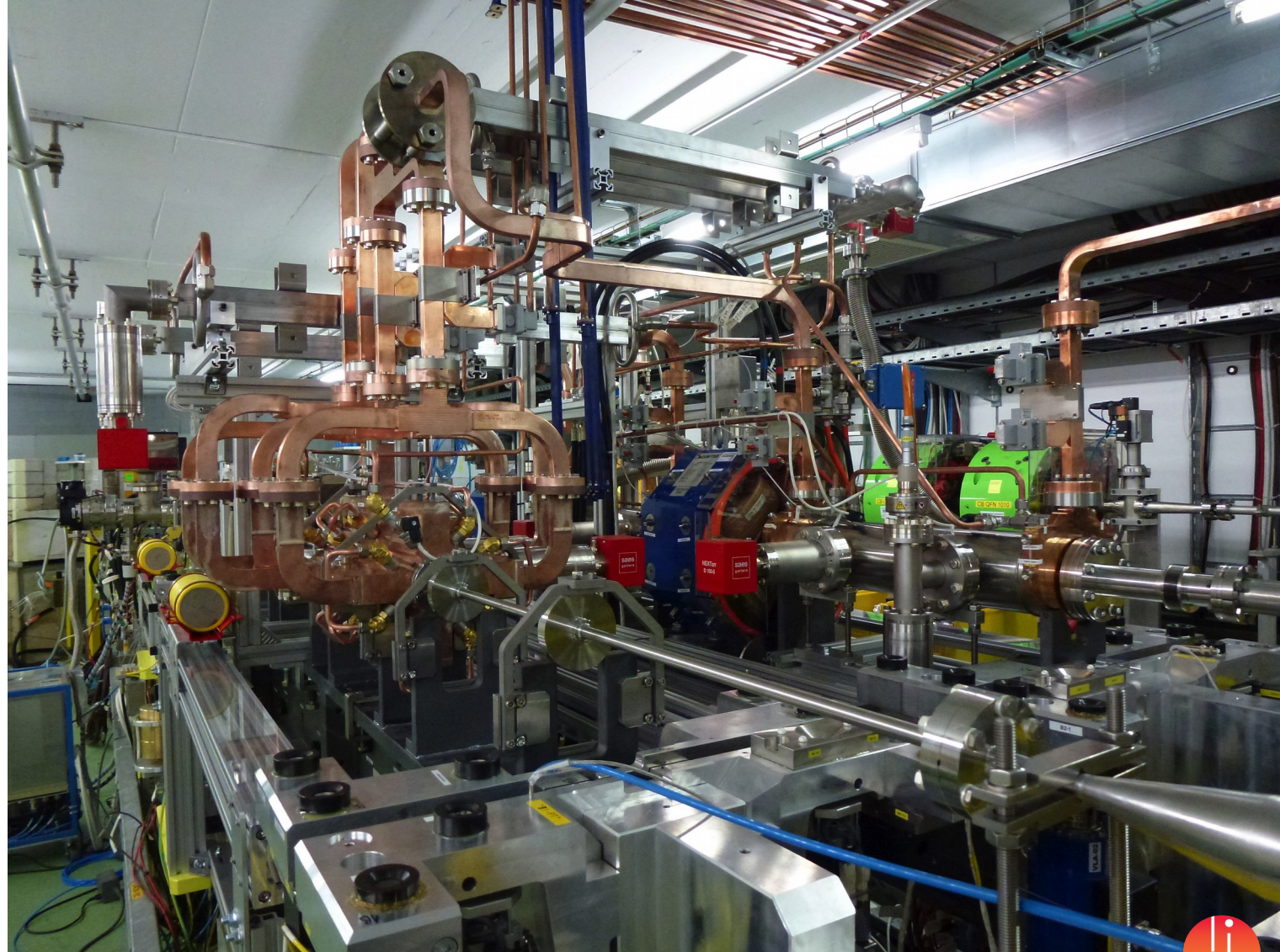

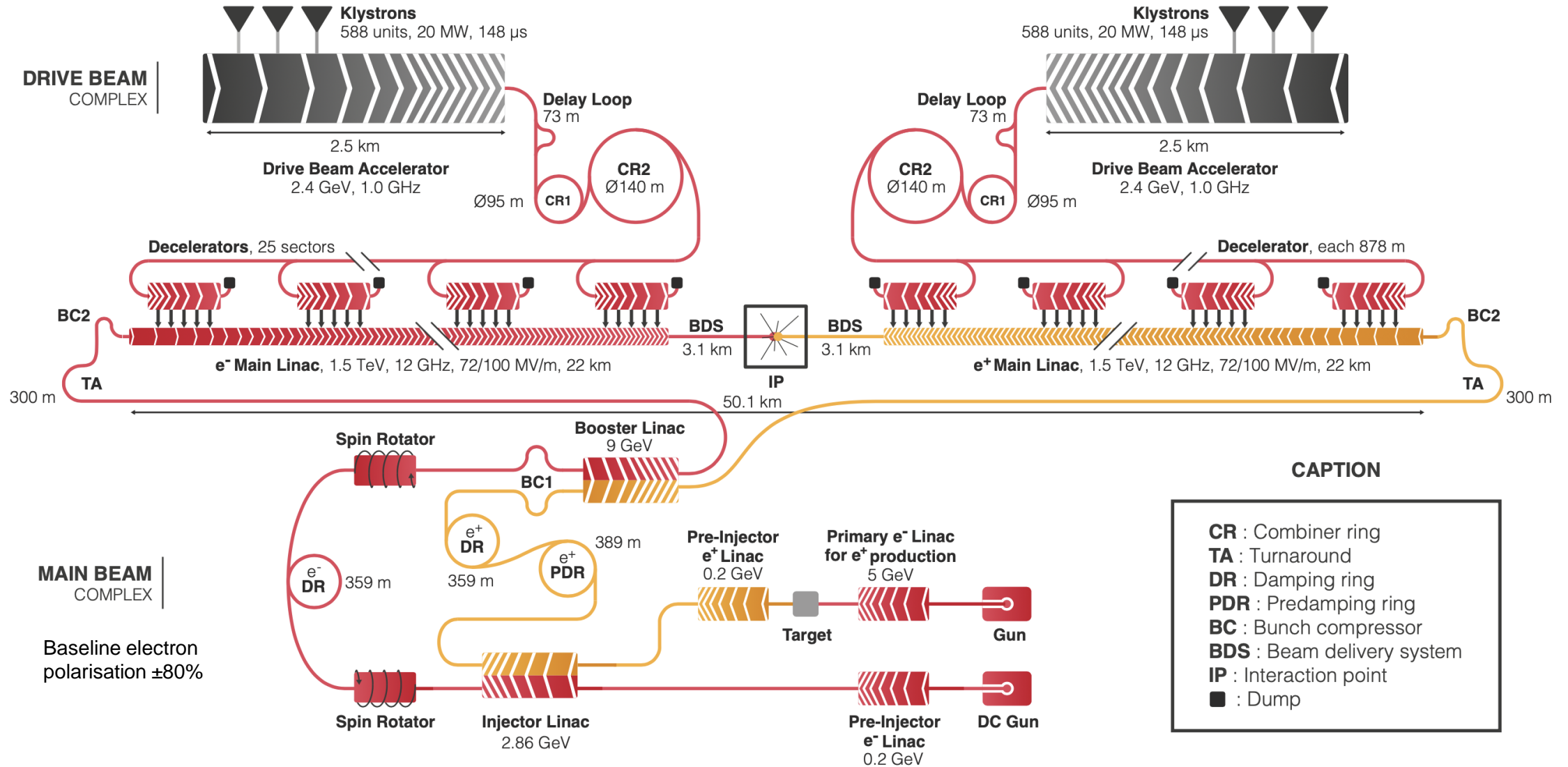



# Updated CLIC Staging

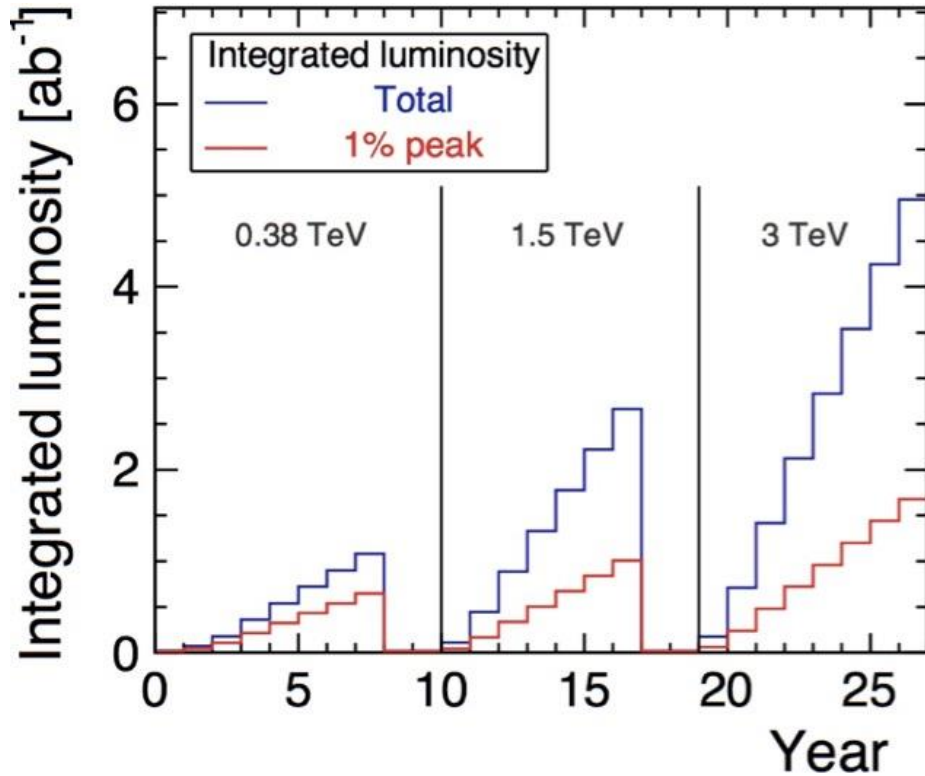

Stage	$\sqrt{s}$ [TeV]	$\mathcal{L}_{\text{int}}$ [ $\text{ab}^{-1}$ ]	increased from
1	0.38 (and 0.35)	1.0	$0.5+0.1\text{ab}^{-1}$
2	1.5	2.5	$1.5\text{ab}^{-1}$
3	3.0	5.0	$3\text{ab}^{-1}$

Electron polarisation enhances Higgs production at high-energy stages and provides additional observables

Baseline polarisation scenario adopted:  
 electron beam (−80%, +80%) polarised in ratio (50:50) at  $\sqrt{s}=380\text{GeV}$  ; (80:20) at  $\sqrt{s}=1.5$  and 3TeV

Staging and live-time assumptions following guidelines consistent with other future projects: Machine Parameters and Projected Luminosity Performance of Proposed Future Colliders at CERN [arXiv:1810.13022](https://arxiv.org/abs/1810.13022), Bordry et al.

# Accelerator challenges

## Four challenges:

### High-current drive beam bunched at 12 GHz

- Power transfer + main-beam acceleration
- ~100 MV/m gradient in main-beam cavities
- Alignment & stability

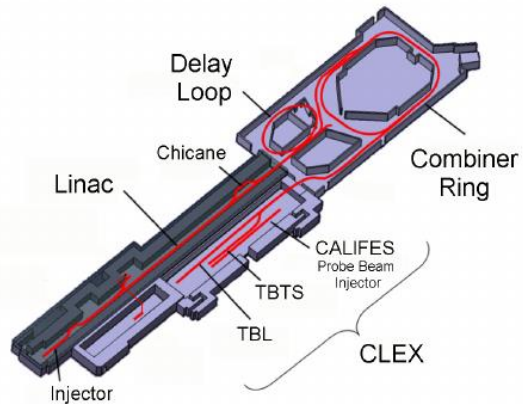

Drive beam quality:  
Produced high-current drive beam bunched at 12GHz

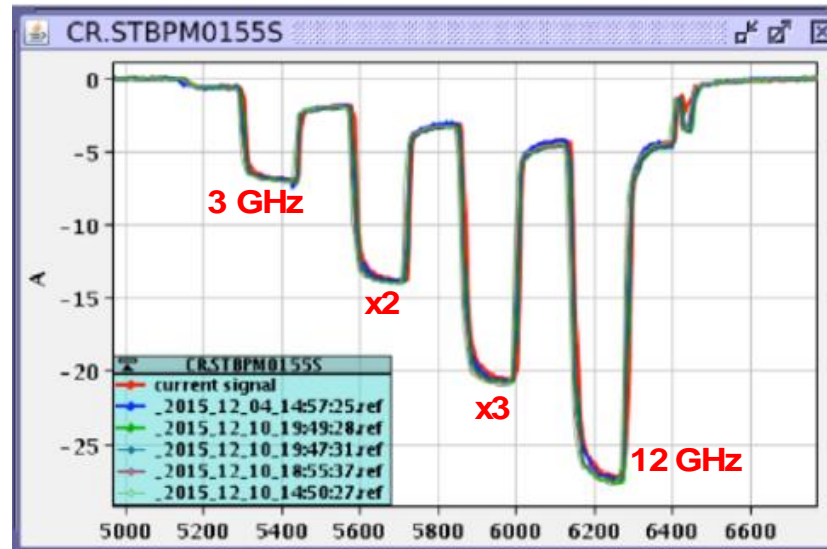

Current in combiner ring

28A  
←

Drive beam arrival time stabilised to CLIC specification of 50fs

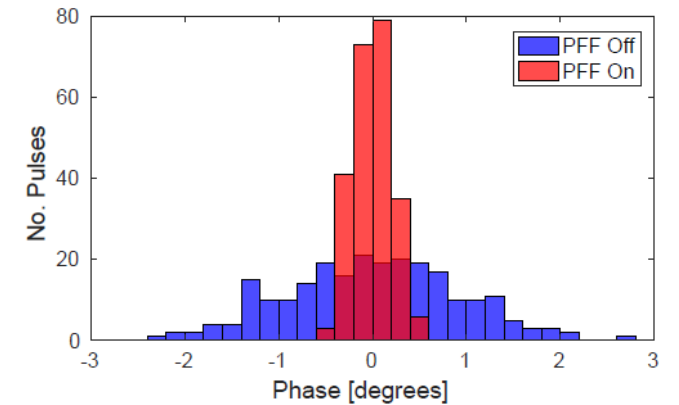

Examples of measurements from CLIC Test Facility, CTF3, at CERN.

CTF3 now the 'CERN Linear Electron Accelerator for Research' facility, CLEAR

# Emittance targets

2008

Vertical emittance [pm]

Horizontal emittance [nm]

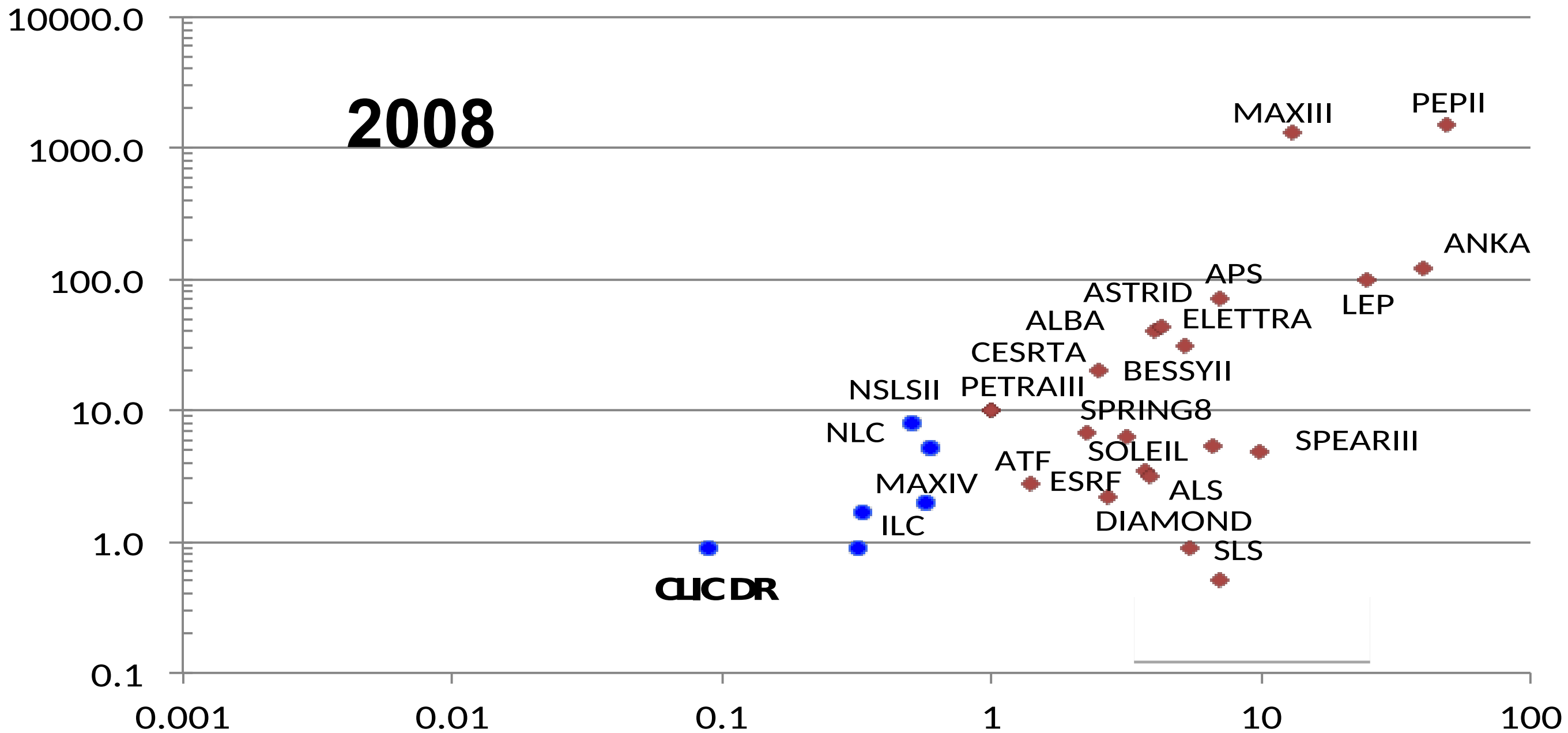

# Emittance targets

2017

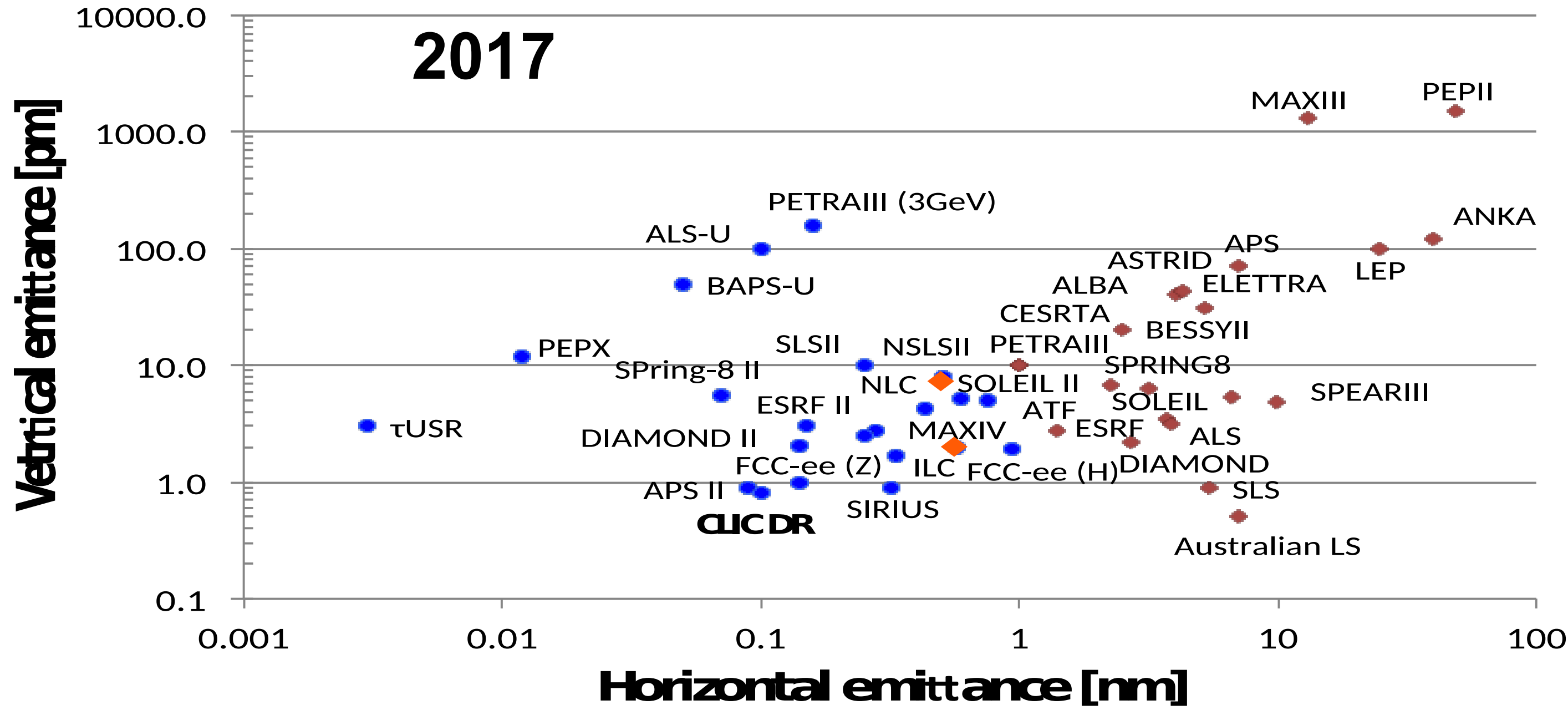

# X-band technology base now very wide

- X-band activities and studies in institutes and industry (intensity linked to resources, publications ... )
- Similar maps possible to draw for Asian and US activities (and for other technologies than X-band)
- X-band used as part of machines (linearizers, deflectors) or as main RF





# Compact



EU funded design study for a compact and low-cost XFEL.

Target - SwissFEL performance at half the cost, to bring XFELs to national and regional facilities.

Based on advances in:

- Injectors
- X-band linac technology
- Undulators

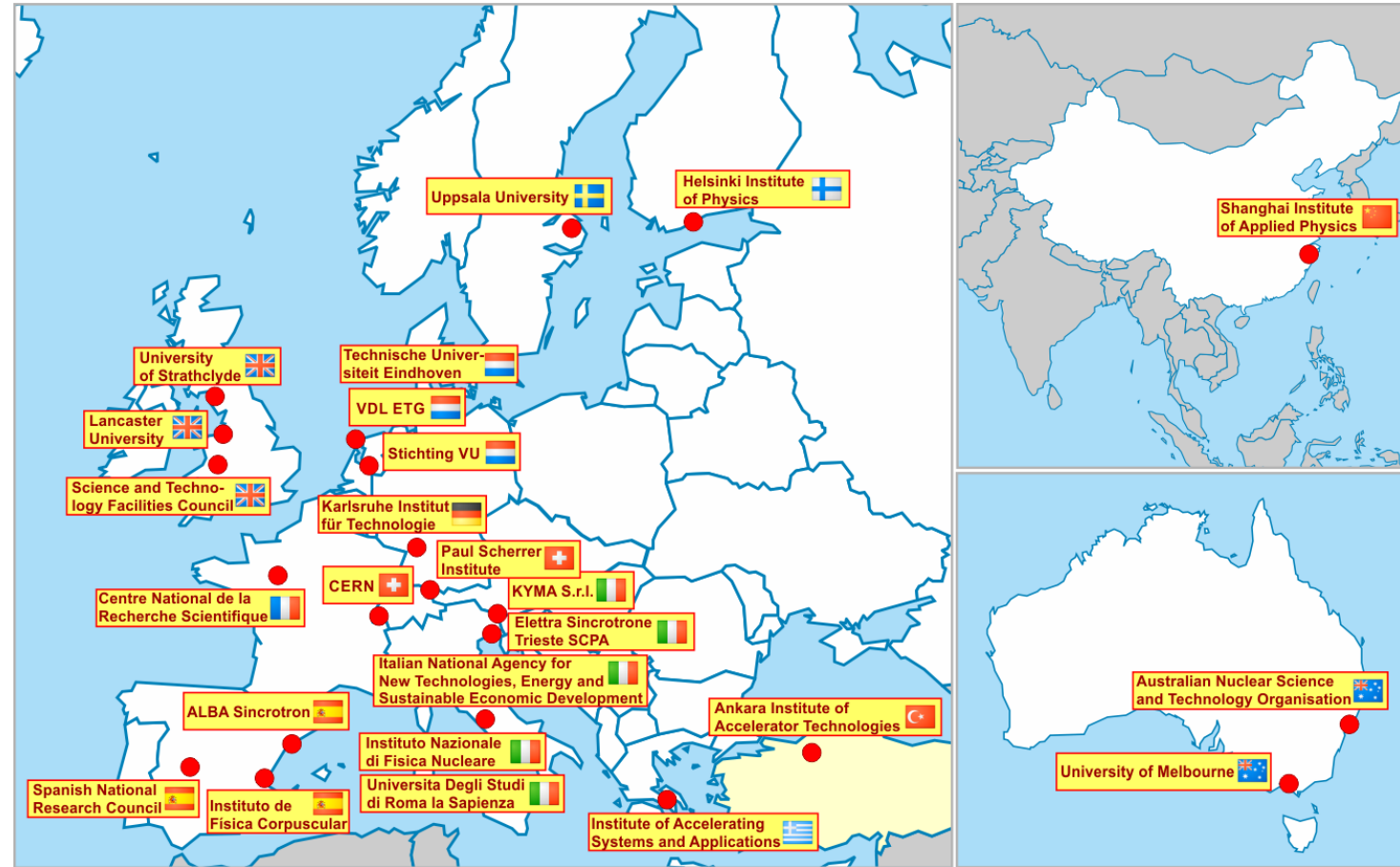

Key technologies have been demonstrated  
CLIC is now a mature project ready for implementation

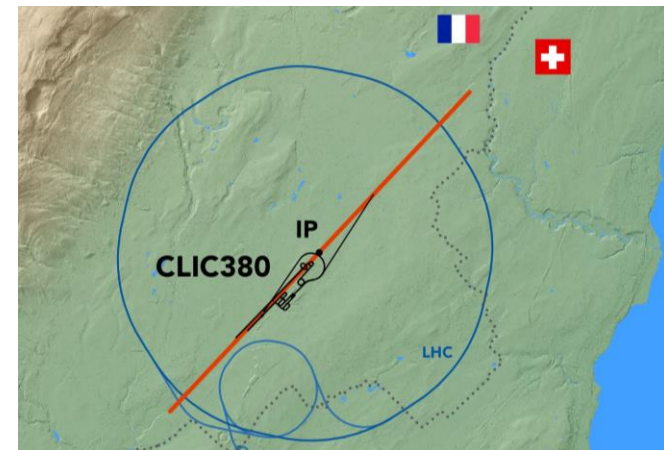
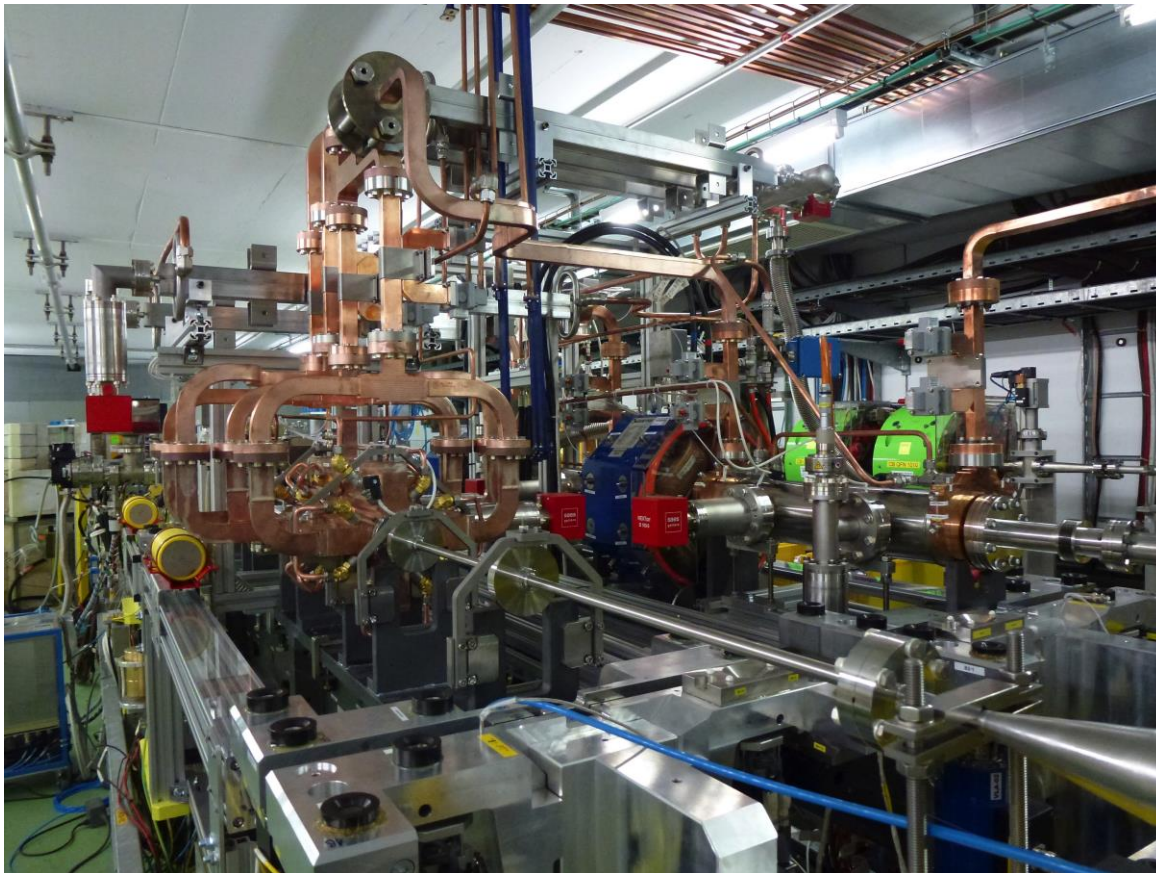

# CLICdet

## Detector Concept for CLIC

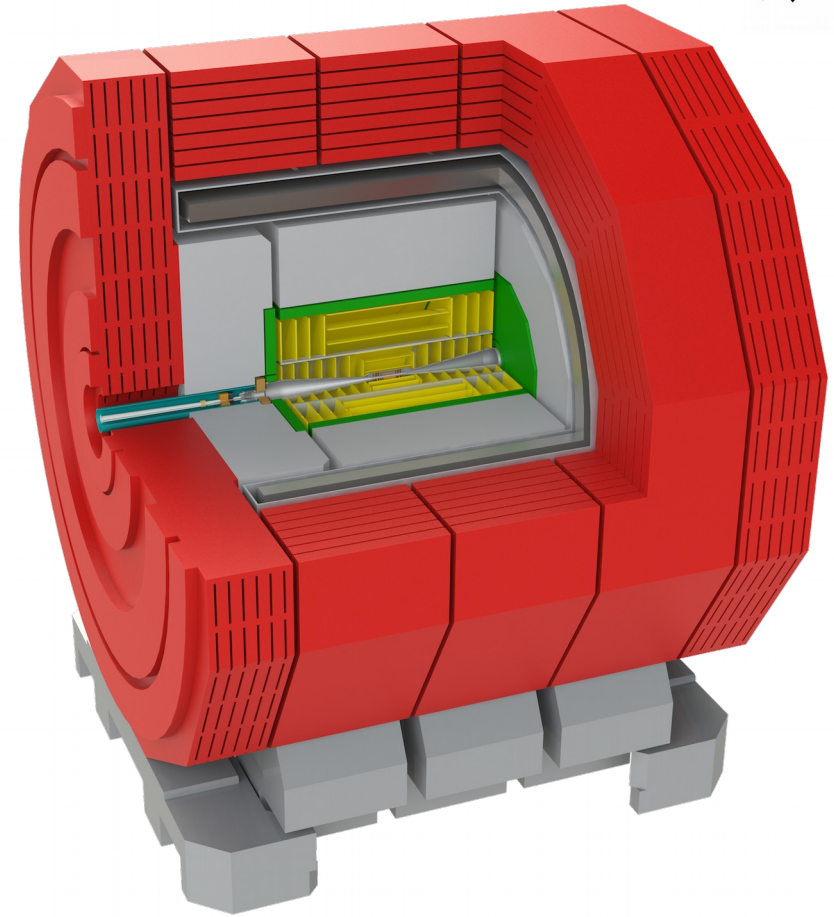



# Experimental Conditions

- CLIC operates in bunch trains, repetition rate of 50 Hz
  - Low duty cycle
  - Possibility for power pulsing: switch detector components off between trains to reduce heat dissipation
- 312 bunches within train (at 3 TeV), separated by 0.5 ns
- Bunch separation & cross-section of background events drive timing requirements for detector
  - 1 ns time resolution for calorimeters
  - 5 ns single-hit resolution for vertex/tracking detectors

CLIC@3TeV

beam structure

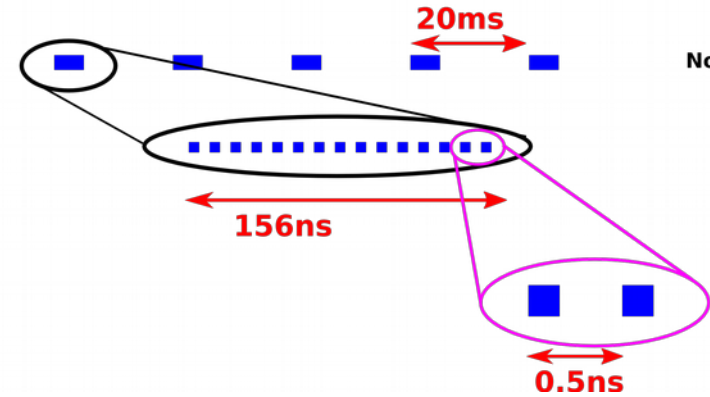

Not to scale



# CLICdet – the CLIC detector Concept

- Low-mass all-silicon vertex and tracking detectors,  $R = 1.5$  m
- High-granularity calorimeters:
  - ECAL:  $22 X_0 + 1 \lambda_I$   
40 layers Si sensors, W plates
  - HCAL:  $7.5 \lambda_I$   
60 layers plastic scintillator/SiPM, steel
- 4T superconducting solenoid
- Return yoke,  
Muon detectors interleaved
- **Optimized for Particle Flow Analysis**

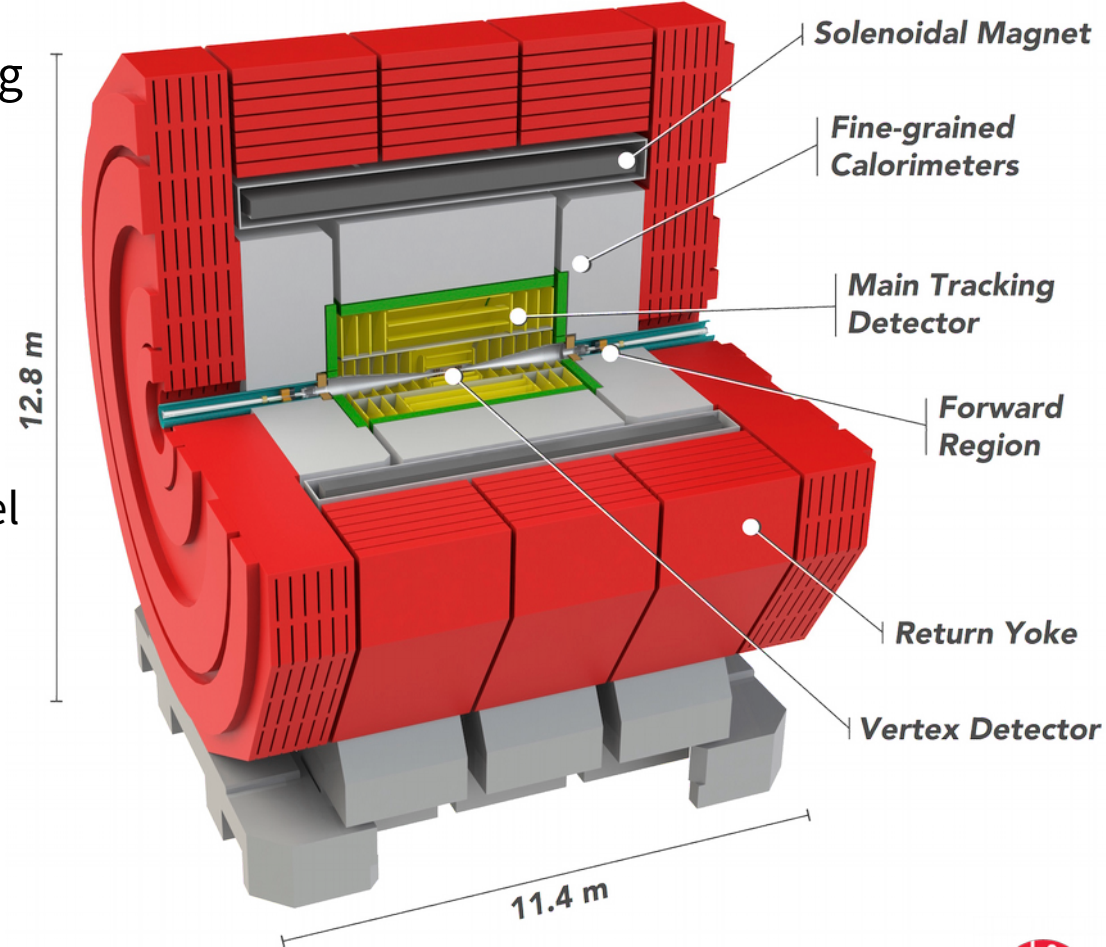

# CLICdet Tracking Performance

- Achieved momentum resolution  $2 \times 10^{-5} \text{ GeV}^{-1}$  for high energy muons in the barrel
- Tracking efficiency very high, negligible impact of background particles  $> 1 \text{ GeV}$
- High efficiency for displaced tracks within acceptance (min. 5 tracker hits required)

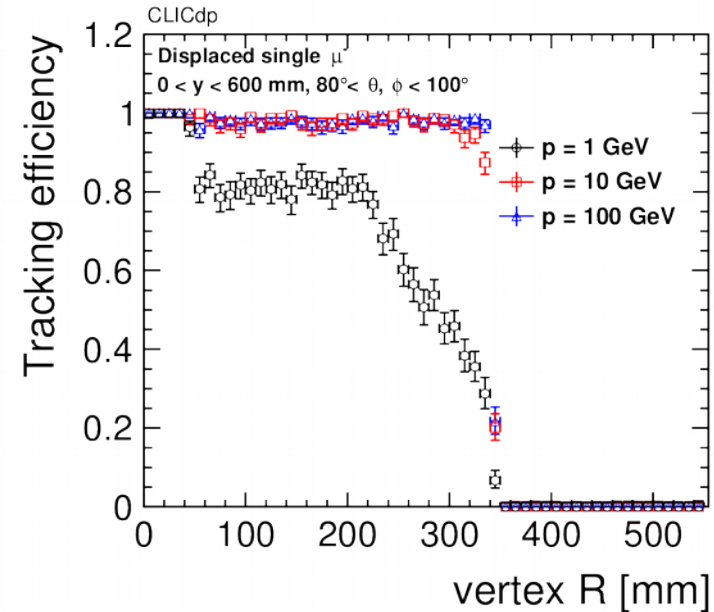
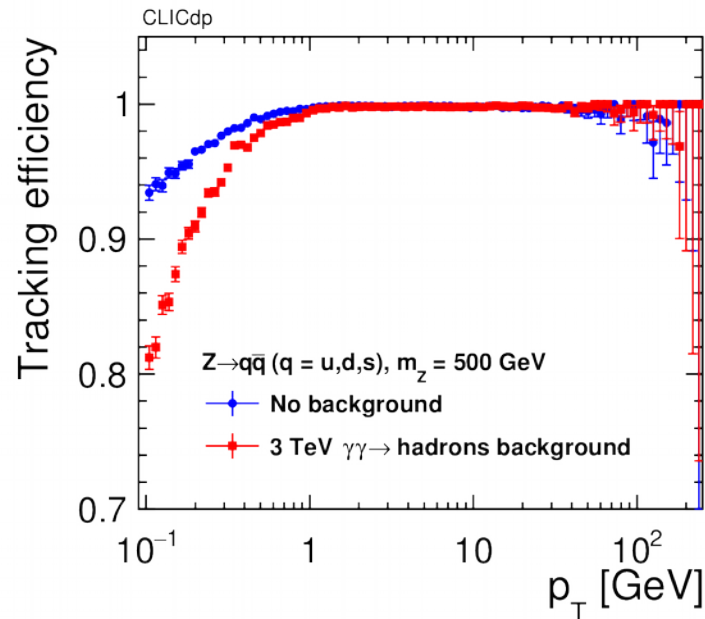
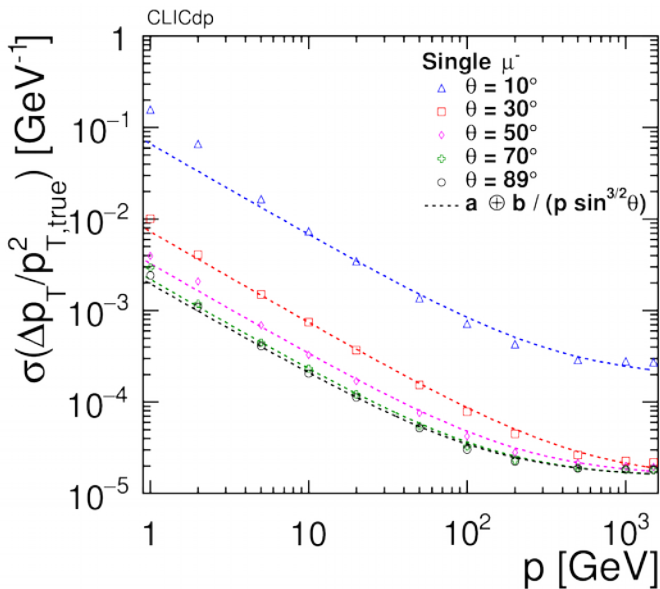

# Flavor Tagging Performance

- Several studies on flavor tagging efficiencies performed, to be found in [performance note](#)
  - LCFIPlus package is used for flavor tagging
- Charm tagging performance
  - Using di-jet samples,  $E_{\text{CM}} = 500$  GeV
  - With and without background (3 TeV, 30 BX)
  - At 80% charm identification efficiency, beauty/light-flavor misidentification is
    - 25% without backgrounds
    - 30% with 3 TeV background overlay

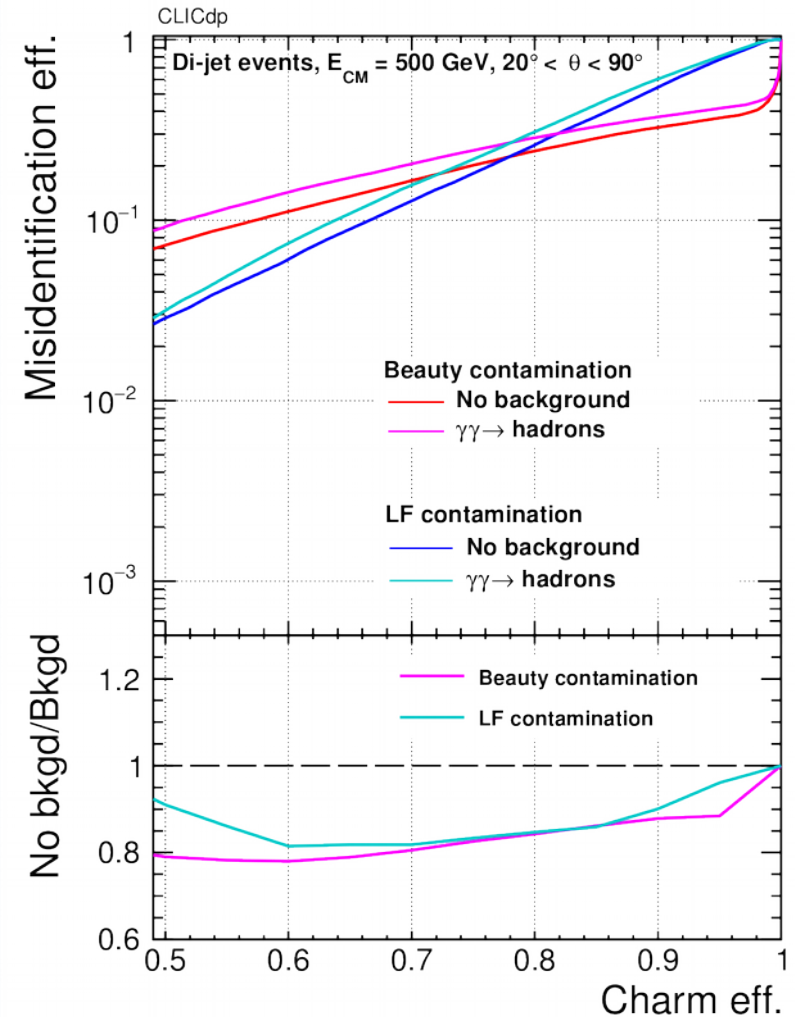

# Jet Reconstruction & Particle Flow Algorithm

- Calorimeter clusters reconstructed via particle flow by **PandoraPFA**
  - Uses reconstructed tracks and muon hits to match calorimeter hits

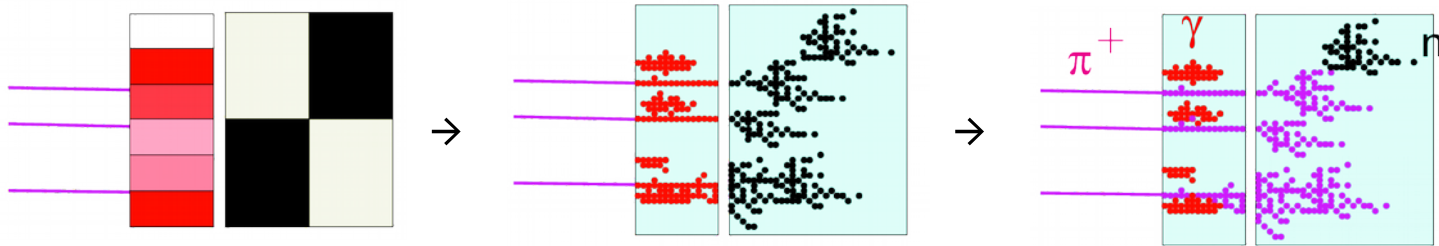

- Requires highly granular calorimeter detectors
- Talk on [Software compensation by F. Simon](#)
- Jets formed using VLC algorithm with  $R = 0.7$
- Dedicated note: [“Jet performance at CLIC” \(CLICdp-Note-2018-004\)](#)

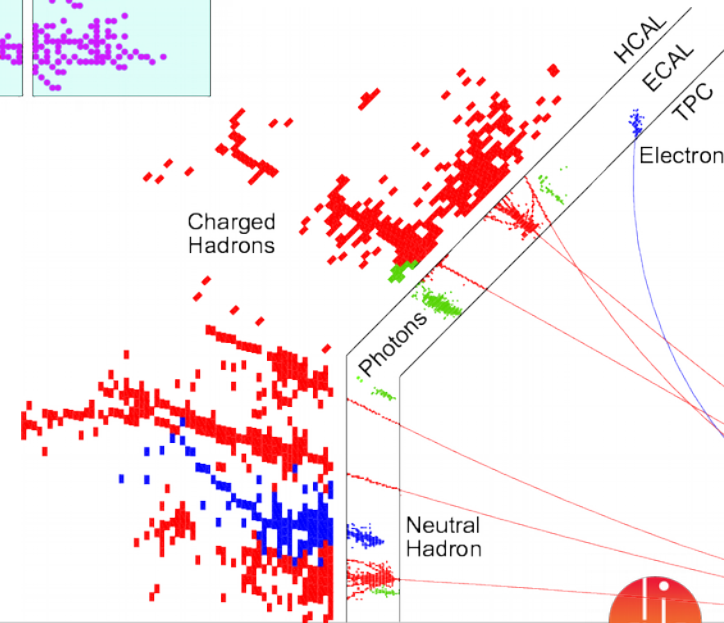

# AHCAL Prototype Test Beam Results

- Many test beam campaigns in 2018 at SPS H2 beam line
  - Calibration with muons, energy scans for  $e^-$ ,  $\pi$
- Prototype can resolve spatial and temporal development of hadronic showers in detail

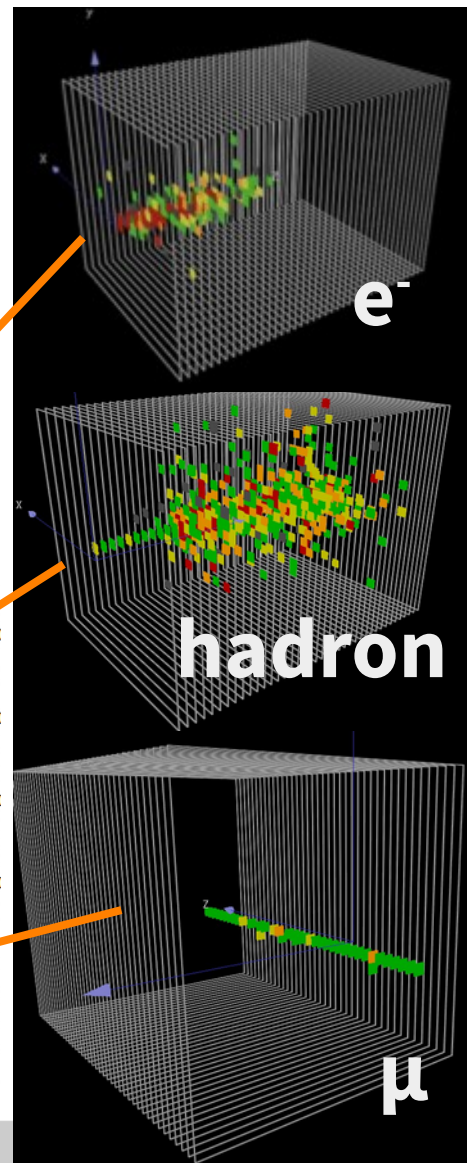
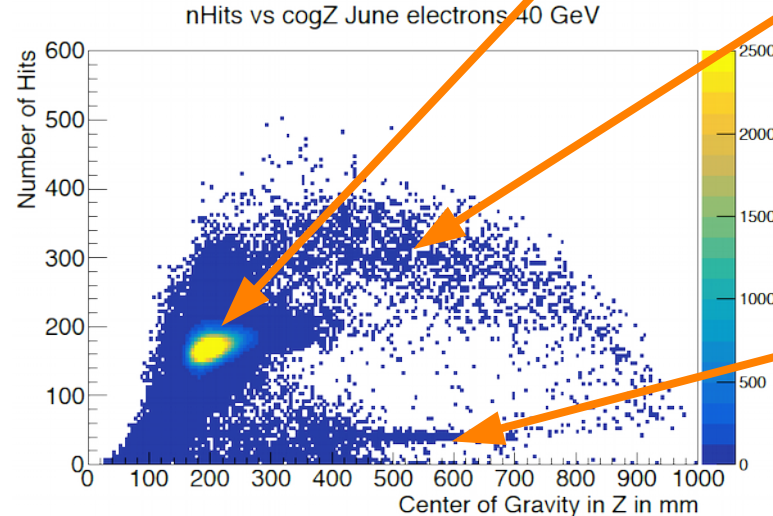
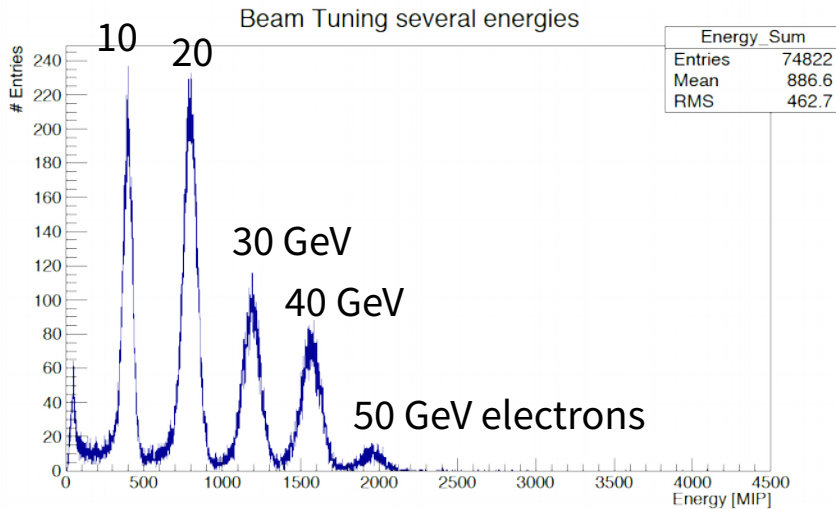

# Jet Energy & Missing $E_T$ Resolution

- Jet energy resolution from  $Z/\gamma^* \rightarrow qq$ , compare reconstructed and MC truth jets
  - Impact from 3 TeV backgrounds especially for low-energy jets, resolution 6-8%
- W/Z mass:  $2\sigma$  separation with VLC7 jets, including 3 TeV backgrounds

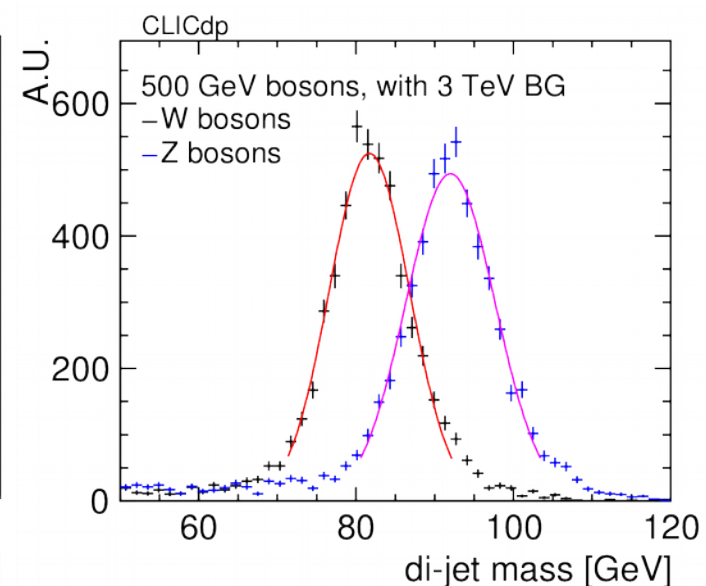
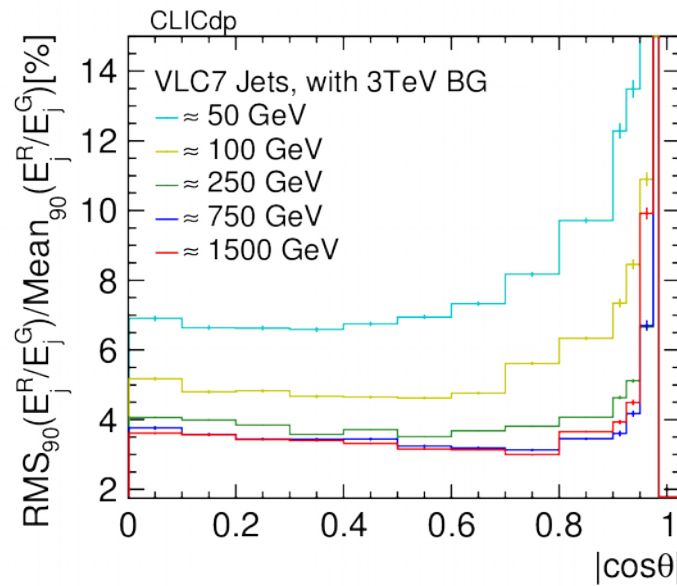
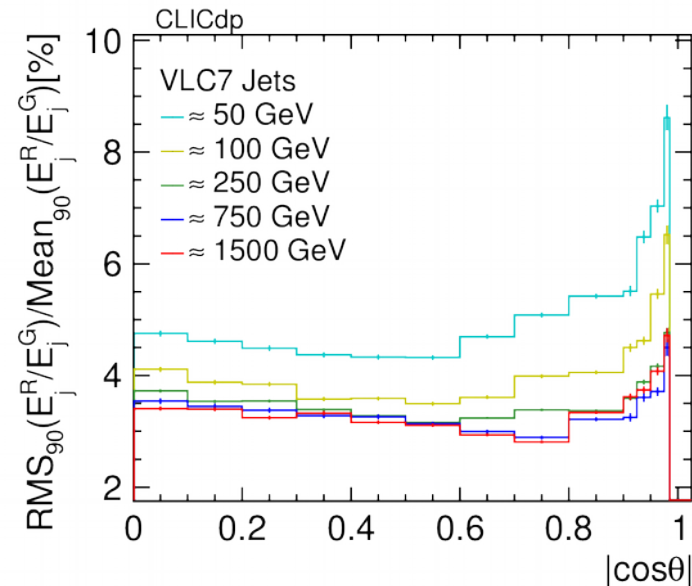

# Background suppression @ 3 TeV

- Fully-hadronic  $t\bar{t}$  event
- Background suppression by
  - Defining reconstruction window 10 ns before, 30 ns after event
  - Building physics objects
  - Suppression via
    - Timing requirements
    - Particle type and  $p_T$
    - Retaining high- $p_T$  objects
  - Cuts adapted per detector region

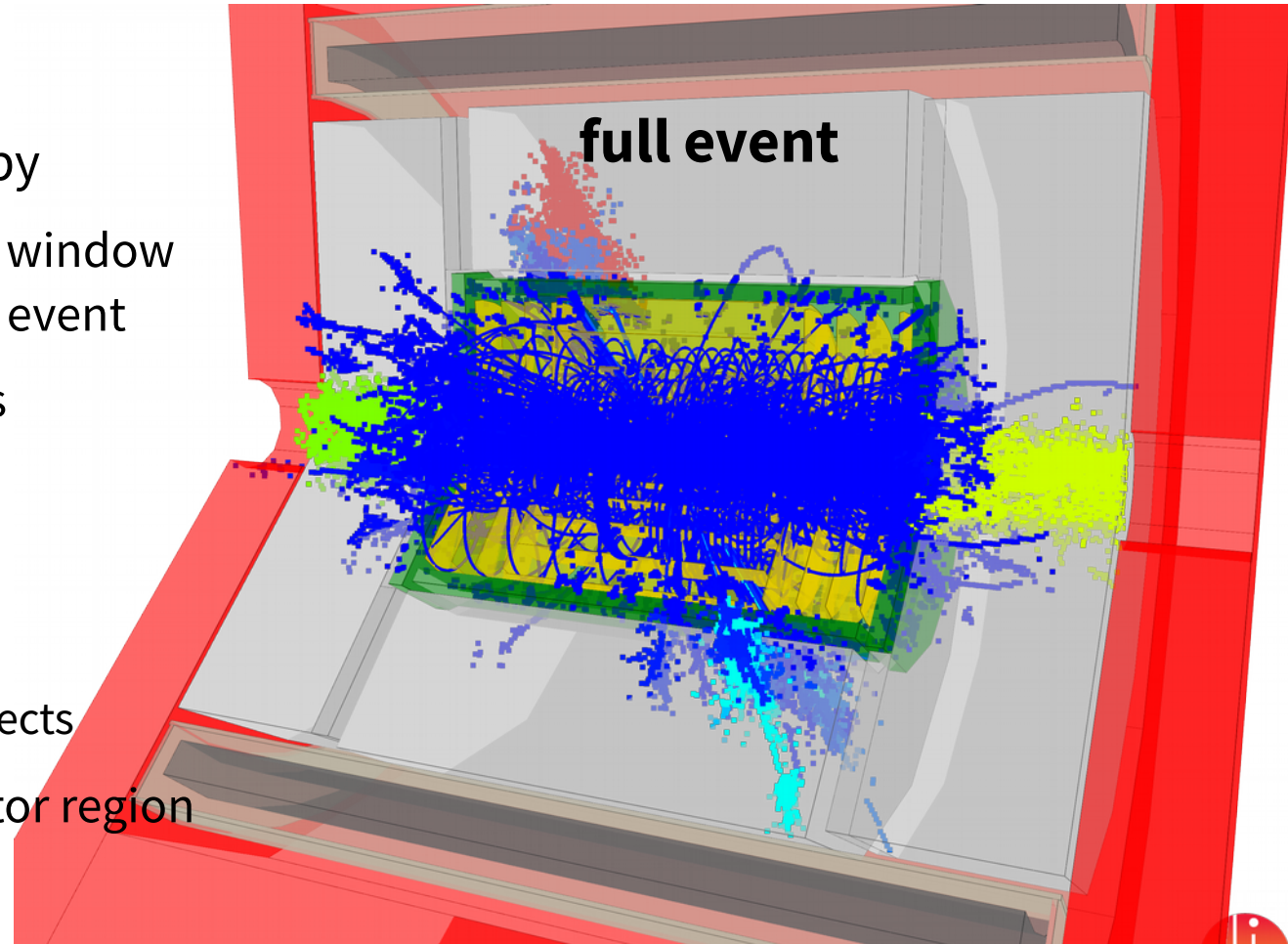



# Background suppression @ 3 TeV

- Fully-hadronic  $t\bar{t}$  event
- Background suppression by
  - Defining reconstruction window 10 ns before, 30 ns after event
  - Building physics objects
  - Suppression via
    - Timing requirements
    - Particle type and  $p_T$
    - Retaining high- $p_T$  objects
  - Cuts adapted per detector region

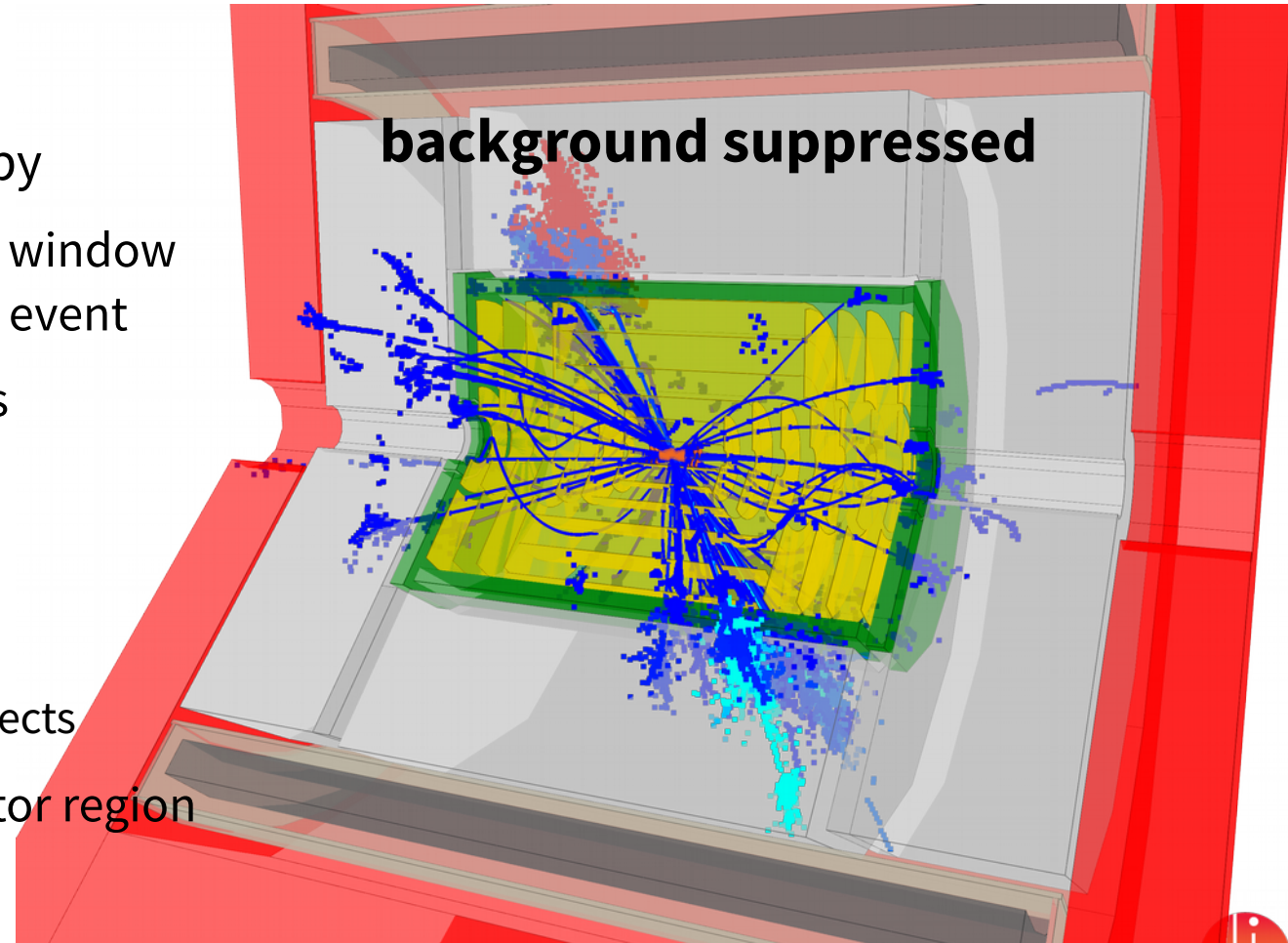

compositeness  $\delta_{\kappa\lambda} = \kappa_\lambda - 1 = \hat{c}_6 - \frac{3}{2}\hat{c}_H$  **hidden valley**  
stub tracks self-coupling **Higgs**  $V_{sr}(\phi) = rg\Lambda^3\phi$   
 $\frac{\Gamma_{h\rightarrow gg}}{\Gamma_{h\rightarrow gg}^{SM}} = 1 + 2\Delta y_t$  SMEFT flavour-changing neutral currents  
 $\mathcal{L}_{\text{eff}} = \mathcal{L}_{\text{SM}} + \frac{1}{\Lambda^2} \sum_i c_i \mathcal{O}_i$   
lepton flavor violation **CLIC search** baryogenesis  
**dark matter**  $W = \frac{g^2 C_{WW}^{\text{eff}}}{m_W^2}$   
**discovery** inert doublet **BSM**  $960\pi^2 m_\chi^2$   
 $I^{WW} \propto A_{++}^{\text{BSM}} [A_{-+}^{\text{SM}} + A_{+-}^{\text{SM}}] \cos 2\varphi$  **2HDM**  
precision mono-photon  $g_t \simeq \epsilon_q \epsilon_t g$   
**see-saw**  $W = 2 \frac{g^2 M_W^2}{g_*^2 M_*^2}$  **Yukawa**  
displacements  $\theta \lesssim \rho \mu^2 / M^2 \simeq \left( \frac{m_-}{m_+} \right)$   
**CLIC** **SUSY** **axion**  
dark matter long-lived

# Physics Program

# CLIC Physics Program – in 3 Stages

- Dedicated [CLICdp Physics session](#) in this workshop (Wed. & Thur.)
- Talk by F. Riva in this session: “Precision Physics and motivations for a high energy LC”

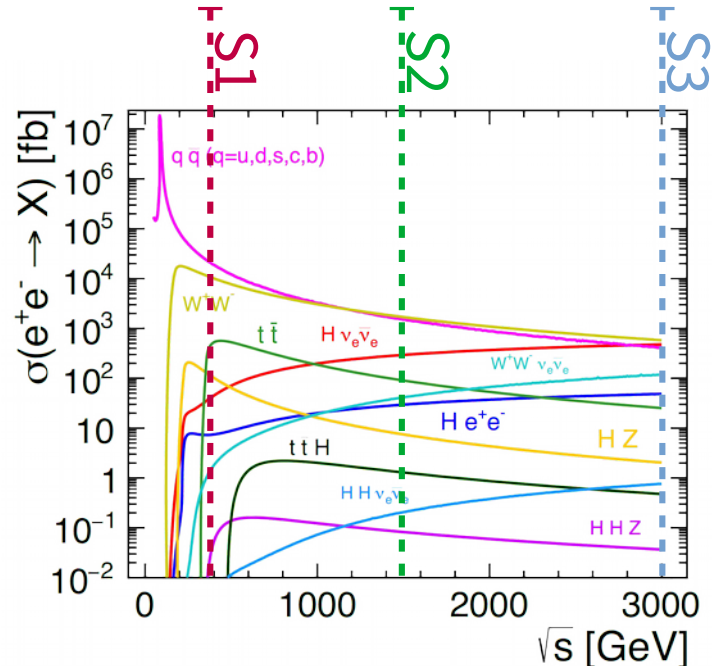

## Stage 1: $\sqrt{s} = 380 \text{ GeV}$ ( $1.0 \text{ ab}^{-1}$ )

- Higgs/top precision physics
- Top mass threshold scan

## Stage 2: $\sqrt{s} = 1.5 \text{ TeV}$ ( $2.5 \text{ ab}^{-1}$ )

- Focus: BSM searches
- Higgs/top precision physics

## Stage 3: $\sqrt{s} = 3 \text{ TeV}$ ( $5.0 \text{ ab}^{-1}$ )

- Focus: BSM searches
- Higgs/top precision physics

# Higgs Physics

- Initial stage: study of Higgs boson production in
  - Higgsstrahlung ( $e^+e^- \rightarrow ZH$ )
  - WW-fusion ( $e^+e^- \rightarrow H \nu_e \nu_e$ )
  - Precise measurements of cross sections, decay width  $\Gamma_H$ , couplings (model-independent)
- High-energy stages:
  - High-statistics WW-fusion samples constrain Higgs couplings
  - Studies of rarer processes ( $e^+e^- \rightarrow ttH$ ,  $e^+e^- \rightarrow HH \nu_e \nu_e$ ) to measure top Yukawa coupling,
  - CLIC only proposed lepton collider for direct meas. of Higgs self-coupling
    - Talk on [Higgs boson self-coupling by U. Schnoor](#)
- **Detailed paper published:**  
 “[Higgs physics at the CLIC electron-positron linear collider](#)”

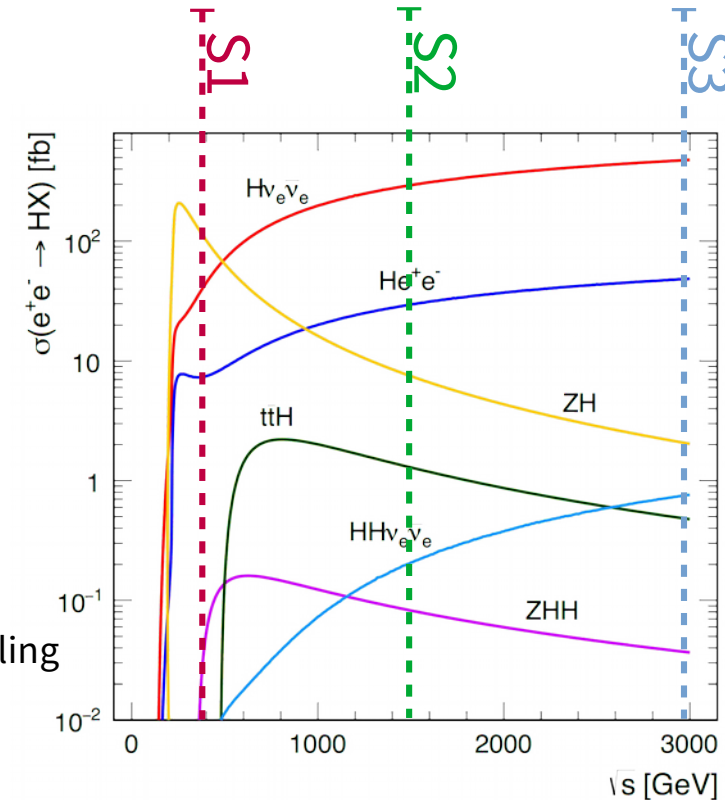

- Three decay modes  $bb/cc/gg$   
 → precise flavour tagging

- Production Mode: ZH or WW fusion  
 → Higgs  $p_T$  spectrum

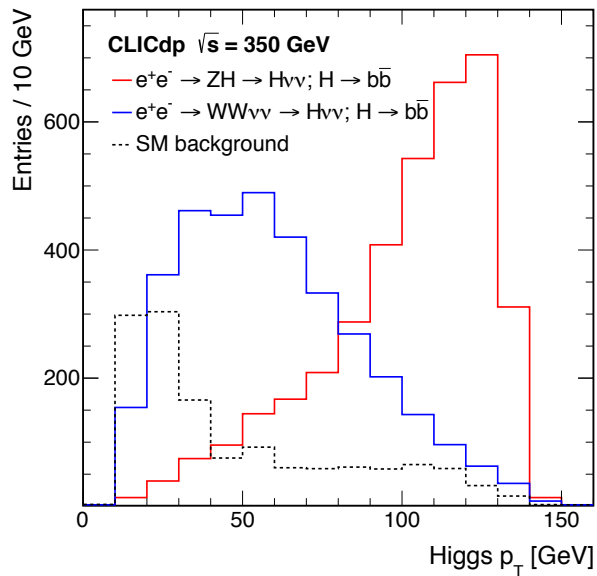

**H → bb**

b) fit template:  $b\bar{b}$   
 ZH; Z → qq; H →  $b\bar{b}$

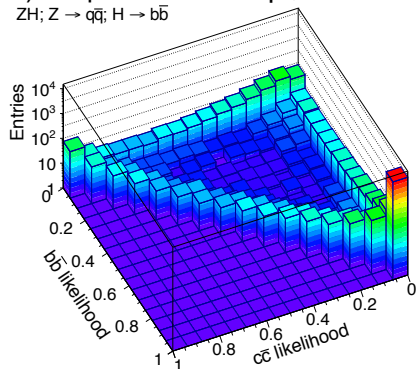

**H → cc**

c) fit template:  $c\bar{c}$   
 ZH; Z → qq; H →  $c\bar{c}$

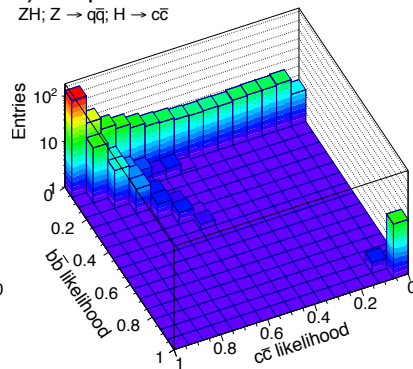

**H → gg**

d) fit template: gg  
 ZH; Z → qq; H → gg

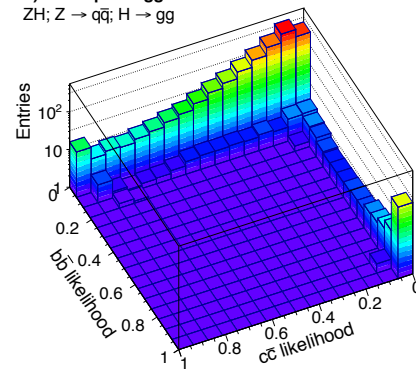

EPJC 76, 72 (2016)  
 arXiv:1708.08912

Fit templates using 2D distributions of  
 bb vs cc likelihoods

Parameter	Relative precision		
	350 GeV $1 \text{ ab}^{-1}$	+ 1.4 TeV $+ 2.5 \text{ ab}^{-1}$	+ 3 TeV $+ 5 \text{ ab}^{-1}$
$g_{\text{HZZ}}$	0.6 %	0.6 %	0.6 %
$g_{\text{HWW}}$	1.0 %	0.6 %	0.6 %
$g_{\text{Hbb}}$	2.1 %	0.7 %	0.7 %
$g_{\text{Hcc}}$	4.4 %	1.9 %	1.4 %
$g_{\text{H}\tau\tau}$	3.1 %	1.4 %	1.0 %
$g_{\text{H}\mu\mu}$	—	12.1 %	5.7 %
$g_{\text{Htt}}$	—	3.0 %	3.0 %
$g_{\text{Hgg}}^\dagger$	2.6 %	1.4 %	1.0 %
$g_{\text{H}\gamma\gamma}^\dagger$	—	4.8 %	2.3 %
$g_{\text{HZ}\gamma}^\dagger$	—	13.3 %	6.7 %
$\Gamma_{\text{H}}$	4.7 %	2.6 %	2.5 %

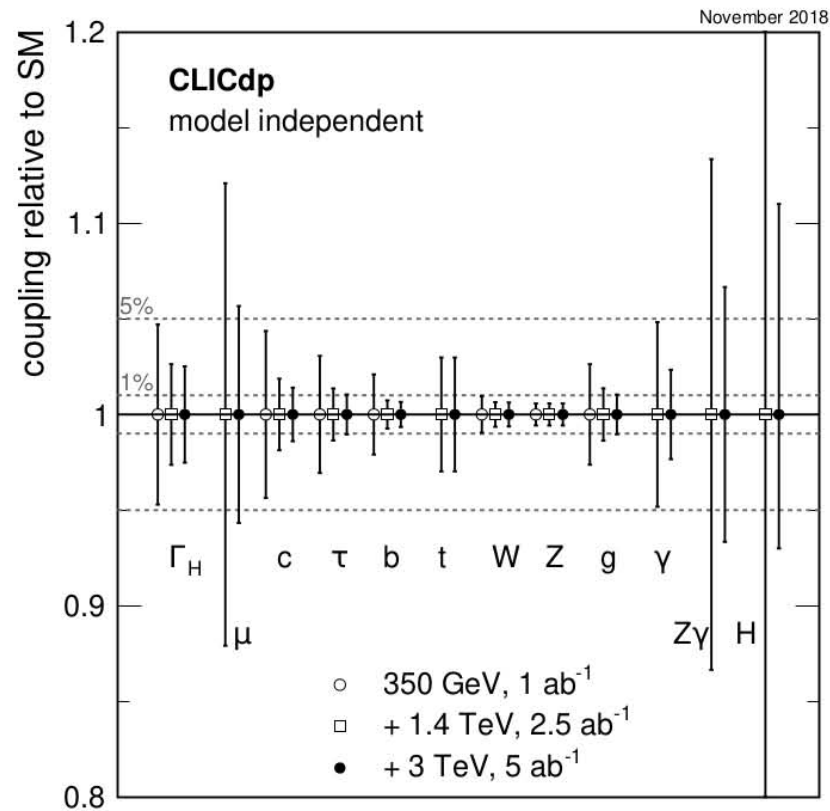

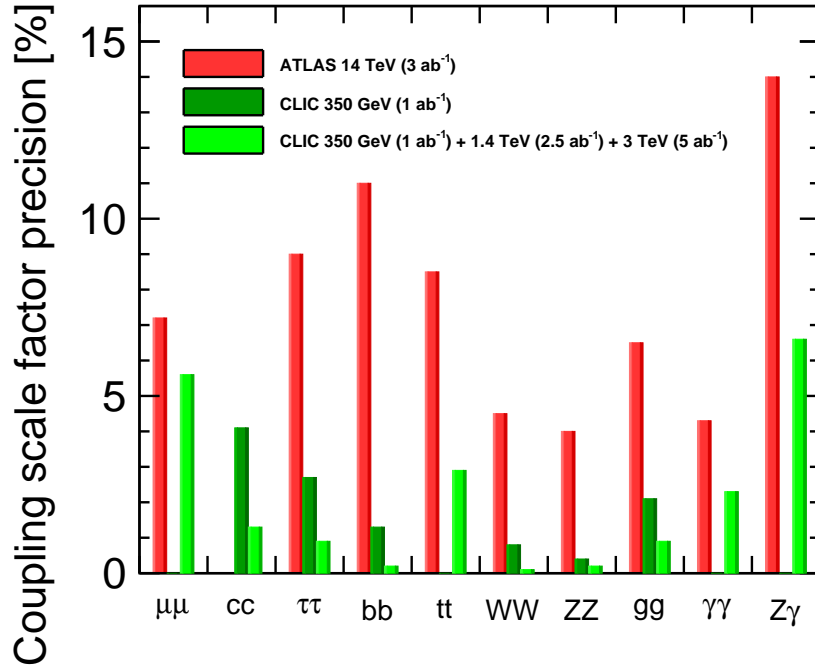

In the SM

- ▶ Higgs potential in SM:  $V = -m_H^2 |\phi|^2 + \lambda |\phi|^4$

⇒ Self-coupling  $\lambda$  determines shape of the potential

- ▶ Relation of mass  $m_H$  and self-coupling  $\lambda$ :

$$m_H^2 = 2\lambda v^2$$

⇒ Relation of mass and self-coupling indicates if the H(125) boson originates from the Higgs field responsible for electroweak symmetry breaking

- ▶ Interaction Lagrangian: trilinear self-coupling

$$g_{HHH} = 6\lambda v$$

Double Higgsstrahlung ZHH

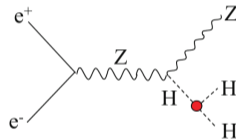

W-boson fusion HH $\nu_e$

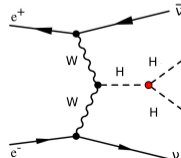



# Higgs pair event numbers

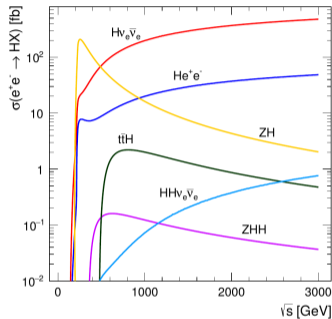

Three energy stages of CLIC –  
Expected numbers of events with two Higgs bosons:

	<b>380 GeV</b> $1 \text{ ab}^{-1}$	<b>1.4 TeV</b> $2.5 \text{ ab}^{-1}$	<b>3 TeV</b> $5 \text{ ab}^{-1}$	
ZHH	$\approx 20$	170	140	
$\text{HH}v_e\bar{v}_e$	$\approx 2$	550	4400	with beam polarisation
$\text{HH}v_e\bar{v}_e$	$\approx 1$	370	3000	without beam polarisation

Eur. Phys. J. C77, 475 (2017)

- ▶ No HH production channel accessible below 500 GeV in  $e^+e^-$
- ▶ ZHH production starts to be accessible at  $\sqrt{s} \gtrsim 500 \text{ GeV}$
- ▶  $\text{HH}v_e\bar{v}_e$  production grows with energy
- ▶ Beam polarisation  $P(e^-) = -80\%$  (+80%): multiply  $\text{HH}v_e\bar{v}_e$  rate by factor 1.8 (0.2)

- ▶ Signal and background samples produced with CLIC\_ILD detector simulation and reconstruction
- ▶ Event selection based on multivariate analysis (BDT), b-tagging of jets

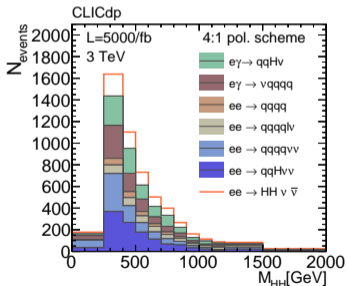
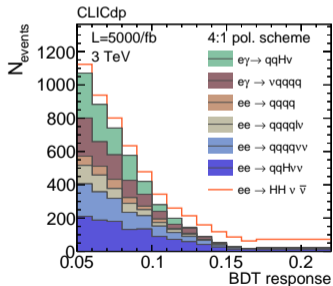

$b\bar{b}b\bar{b}$  analysis:

**Signal region:**

Signal = 766 events

Background = 4527 events

- ▶ Unique capability of CLIC: measuring the Higgs self-coupling to  $-7\%$ ,  $+11\%$  accuracy
- ▶ Direct accessibility of HH production at 1.4 and 3 TeV
- ▶ Challenging measurements: small cross section, forward b-quarks
- ▶ Benefits from excellent heavy flavor tagging, jet energy resolution of CLIC detector

## CLIC double Higgs and Higgs self-coupling programme:

	1.4 TeV	3 TeV
$\sigma(\text{HH}\nu_e\bar{\nu}_e)$	$3.6\sigma$ $\frac{\Delta\sigma}{\sigma} = 28\%$ EVIDENCE	$> 5\sigma$ for $\mathcal{L} \geq 1100 \text{ fb}^{-1}$ $\frac{\Delta\sigma}{\sigma} = 7.3\%$ OBSERVATION
$\sigma(\text{ZHH})$	$5.9\sigma$ OBSERVATION	
$g_{\text{HHH}}/g_{\text{HHH}}^{\text{SM}}$	1.4 TeV: $-34\%$ , $+36\%$ rate only analysis	1.4 & 3 TeV: $-7\%$ , $+11\%$ differential analysis

+ Global EFT fit ( $\rightarrow$  Francesco's talk)

+ BSM interpretation (e.g. Baryogenesis)

$\Rightarrow$  Together with the high-precision Higgs and top physics programme at CLIC, this measurement will clarify the nature of the electroweak symmetry breaking mechanism

# Top-Quark Physics



- Initial stage: focus on
  - top-quark pair production
  - tt pair production threshold scan at 350 GeV
    - Precise measurement of top-quark mass in well-defined theoretical framework
- Higher-energy stages:
  - top-quark pairs in association with other particles
  - ttH production, top Yukawa coupling
  - Vector boson fusion (VBF) production
  - Combine measurements in global fits

## • Detailed paper in journal review:

“Top-Quark Physics at the CLIC Electron-Positron Linear Collider”

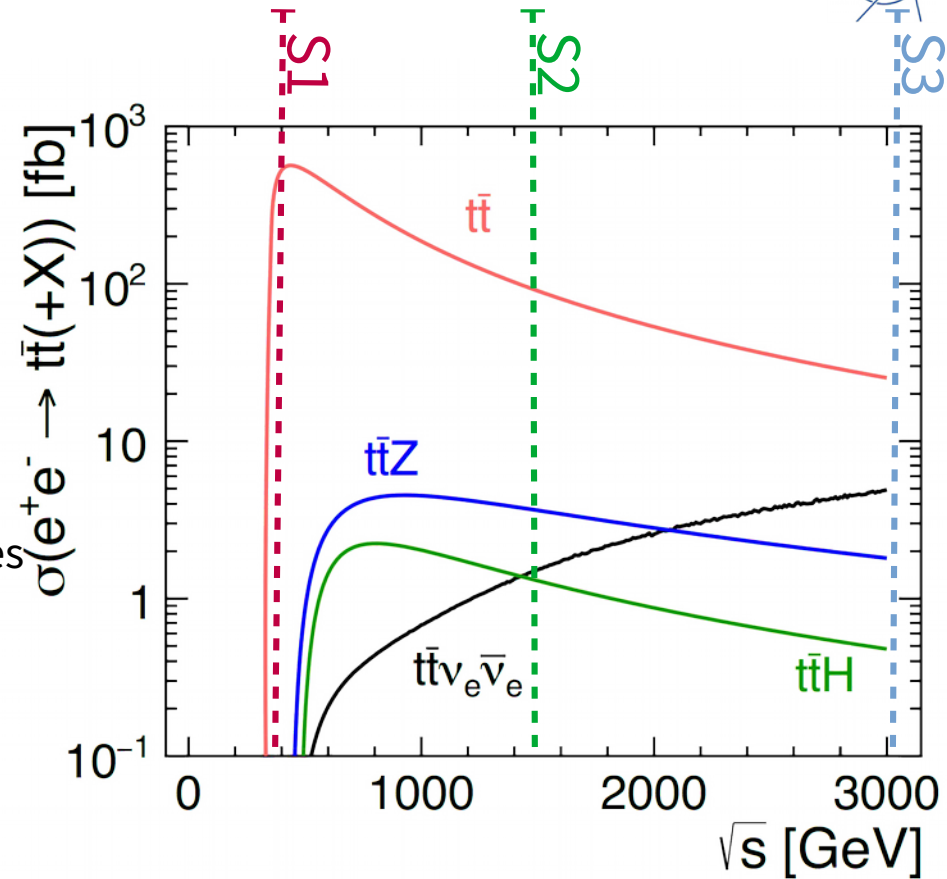

## Top quark pair production events

Reconstructed invariant mass for the hadronic top-quark decays for  $1000 \text{ fb}^{-1}$  at 380 GeV

Hadronic  $t\bar{t}$  selection

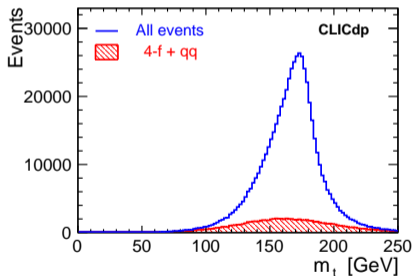

$$\sigma^{\text{stat}} = 30 \text{ MeV}$$

Semi-leptonic  $t\bar{t}$  selection

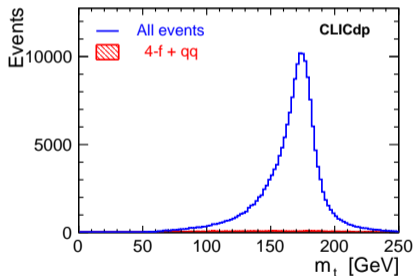

$$\sigma^{\text{stat}} = 39 \text{ MeV}$$

But the systematic uncertainties (JES and **theory**) are much larger!

## Threshold scan

Top pair production cross section around threshold is very sensitive to top-quark mass, width and other model parameters  
 The dependence is smeared by ISR and CLIC luminosity spectra.

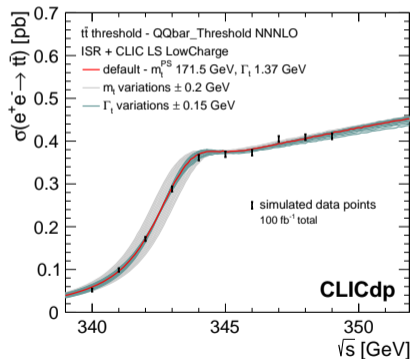
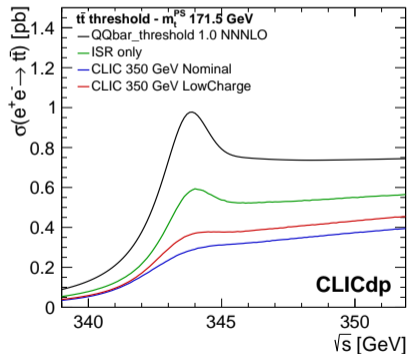

Expected statistical uncertainty for 100 fb<sup>-1</sup> is 19 MeV (dedicated spectra)

## Signal-background discrimination

Pre-selection based on the reconstructed photon energy.

Require  $E_\gamma > 50$  GeV

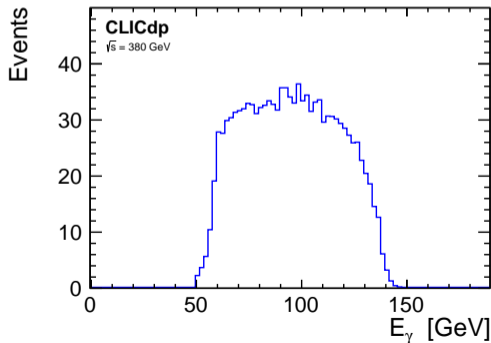

Limit from BDT response distribution for SM background events and FCNC signal distributions shown for  $\text{BR}(t \rightarrow c\gamma) = 10^{-3}$

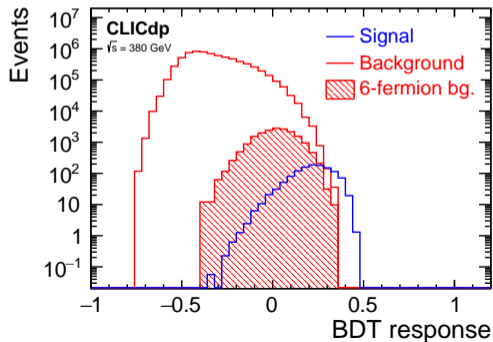

## Final results

Reconstructed  $c\gamma$  invariant mass  
For BDT selection cut,  $\text{BDT} > 0.29$

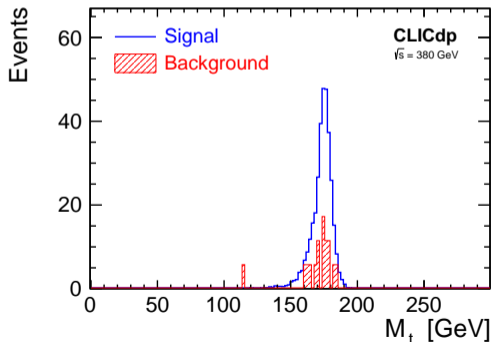

Expected limits for  $1000 \text{ fb}^{-1}$  collected at  
380 GeV CLIC

calculated using the  $\text{CL}_s$  approach

$$\text{BR}(t \rightarrow c\gamma) < 2.6 \cdot 10^{-5}$$



## Multivariate analysis

Used for final signal vs background discrimination

Hadronic sample

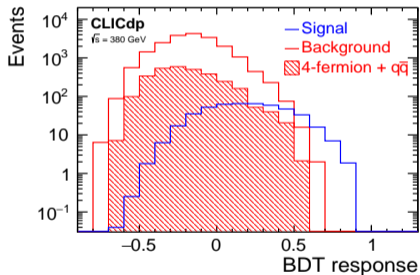

Semi-leptonic sample

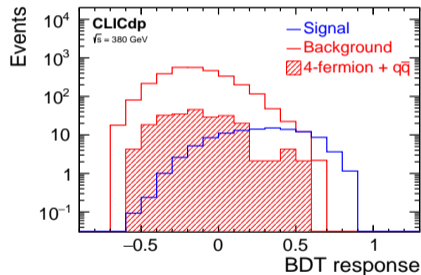

**Expected limit** 95% CL,  $1000 \text{ fb}^{-1}$  collected at 380 GeV

$CL_s$  method applied to BDT response distributions

$$\text{BR}(t \rightarrow cH) \times \text{BR}(H \rightarrow b\bar{b}) < 8.8 \cdot 10^{-5}$$

## Results

Expected limits for  $1000 \text{ fb}^{-1}$  collected at 380 GeV CLIC  
calculated using the  $CL_s$  approach

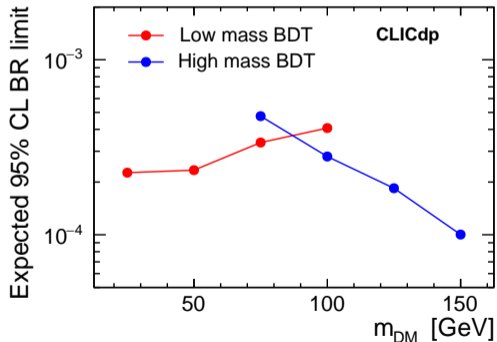

$$BR(t \rightarrow c\cancel{E}) < 1.0 - 3.4 \cdot 10^{-4}$$

# Precision (B)SM Tests

At High Energy: Infinite Observables  $\rightarrow$  ~~Infinite~~ <sup>finite</sup> Information

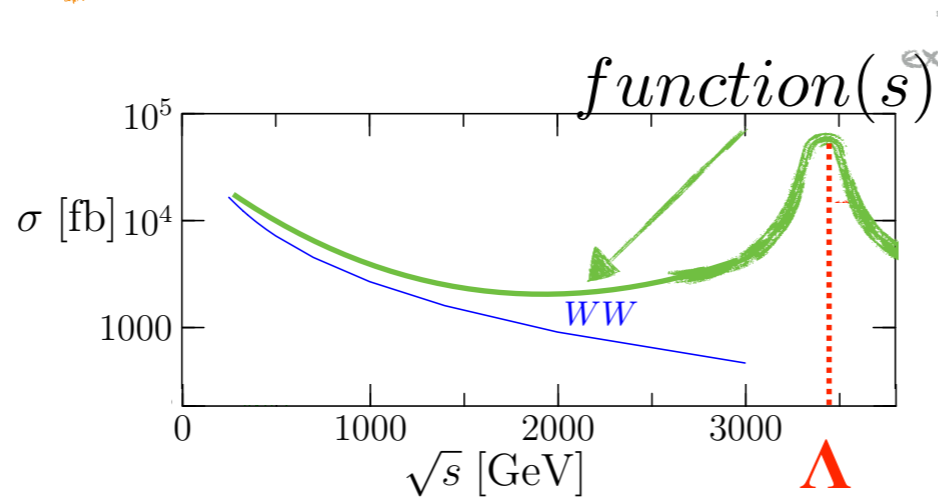
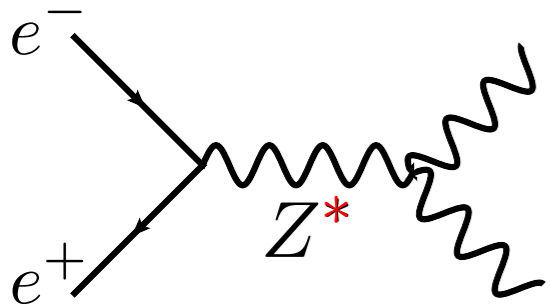

Taylor expansion

$$= f(0) + f'(0)s + f''(0)s^2 + \dots$$

Effective Field Theory (EFT)  
= systematic Taylor expansion for all observables

It captures **all** heavy new physics  $\rightarrow$

$$\mathcal{L}_{\text{eff}} = \mathcal{L}_{\text{SM}} + \frac{1}{\Lambda^2} \sum_i c_i \mathcal{O}_i + \dots$$

$f(0)$  and  $f'(0)$  at same order  
(dimension-6 EFT)

# Global Fit

to all universal effects

precision reach of the Universal EFT fit

new physics couples only to bosons

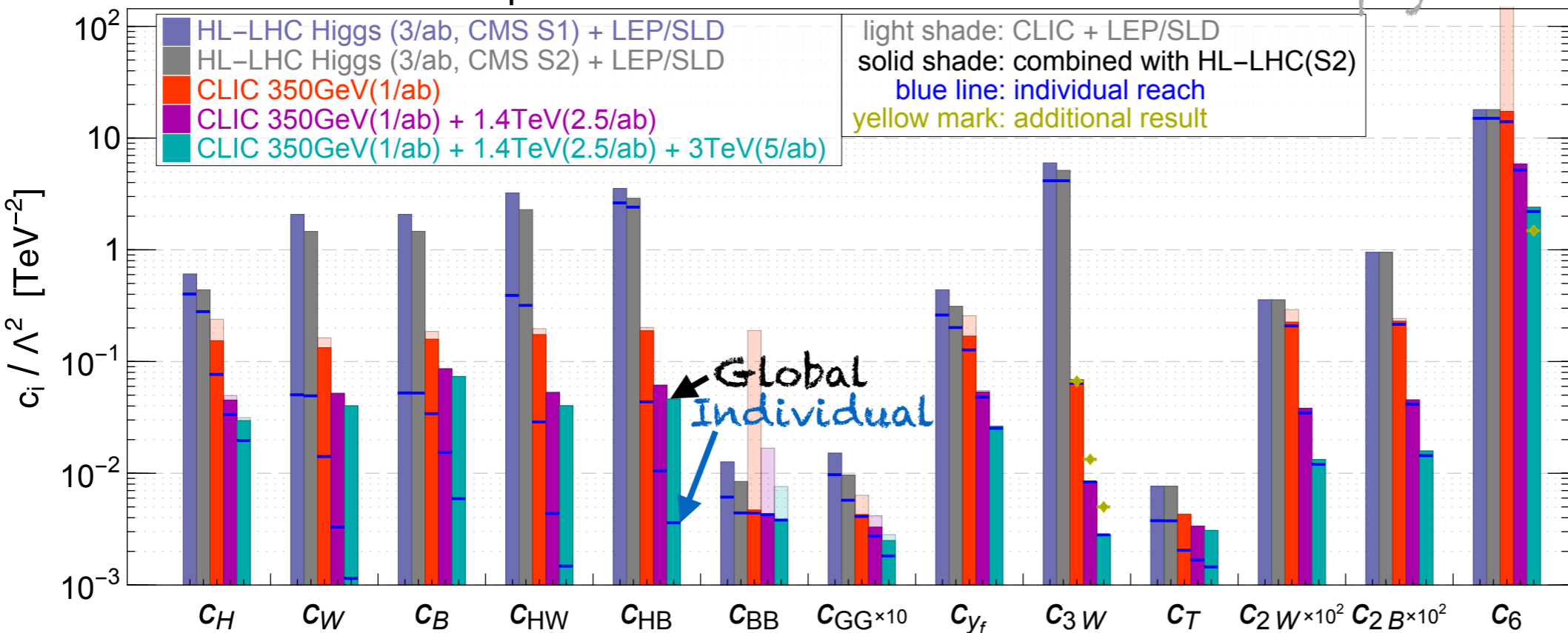

BSM Reach

$\approx 1$  TeV

$\approx 3$  TeV

$\approx 10$  TeV

Correlation, CLIC 350GeV+1.4TeV+3TeV

$C_H$	100	9	-17	-4	13	2	-62	-12	0	9	4	-2
$C_W$	9	100	-68	-95	94	8	-3	16	0	-8	2	-1
$C_B$	-17	-68	100	42	-88	-6	0	-9	-1	62	-6	6
$C_{HW}$	-4	-95	42	100	-79	-7	4	-16	0	-15	0	-1
$C_{HB}$	13	94	-88	-79	100	8	-2	14	1	-34	4	-4
$C_{BB}$	2	8	-6	-7	8	100	2	7	0	0	0	0
$C_{GG}$	-62	-3	0	4	-2	2	100	4	0	0	0	0
$C_{Yf}$	-12	16	-9	-16	14	7	4	100	0	6	1	0
$C_{3W}$	0	0	-1	0	1	0	0	0	100	-1	0	0
$C_T$	9	-8	62	-15	-34	0	0	6	-1	100	0	4
$C_{2W}$	4	2	-6	0	4	0	0	1	0	0	100	-42
$C_{2B}$	-2	-1	6	-1	-4	0	0	0	0	4	-42	100

Single Higgs

WW/ZH

Single Higgs

Drell-Yann

Double Higgs

## EFT interpretation

Possible BSM effects induced by heavy new physics (above the direct reach of CLIC) are universally described by Effective Field Theory (EFT)

Top-quark measurements at CLIC can be used to constrain 7 operators:

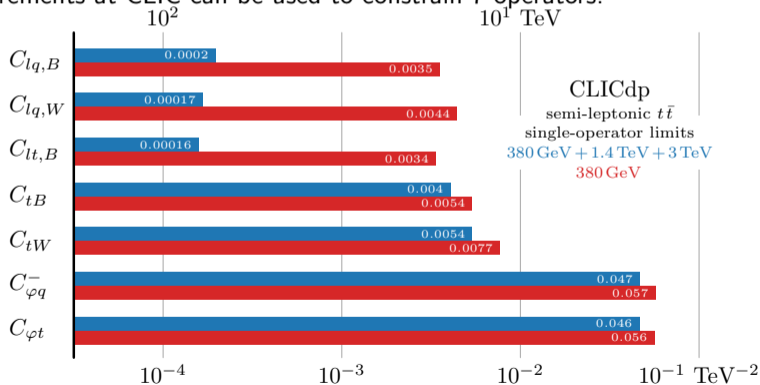

First CLIC stage crucial for constraining 4 operators

# Heavy Scalar Singlets

Heavy neutral spin-0 appear in many BSM scenario

$\phi$ - $h$  mix:

$\phi = S \cos \gamma - h_0 \sin \gamma$ ,  $\rightarrow$  inherit Higgs couplings  $\rightarrow$  Direct Searches

$h = h_0 \cos \gamma + S \sin \gamma$ ,  $\rightarrow$  reduce Higgs couplings  $\rightarrow$  Indirect Searches

Buttazzo, Redigolo, Sala, Tesi'18

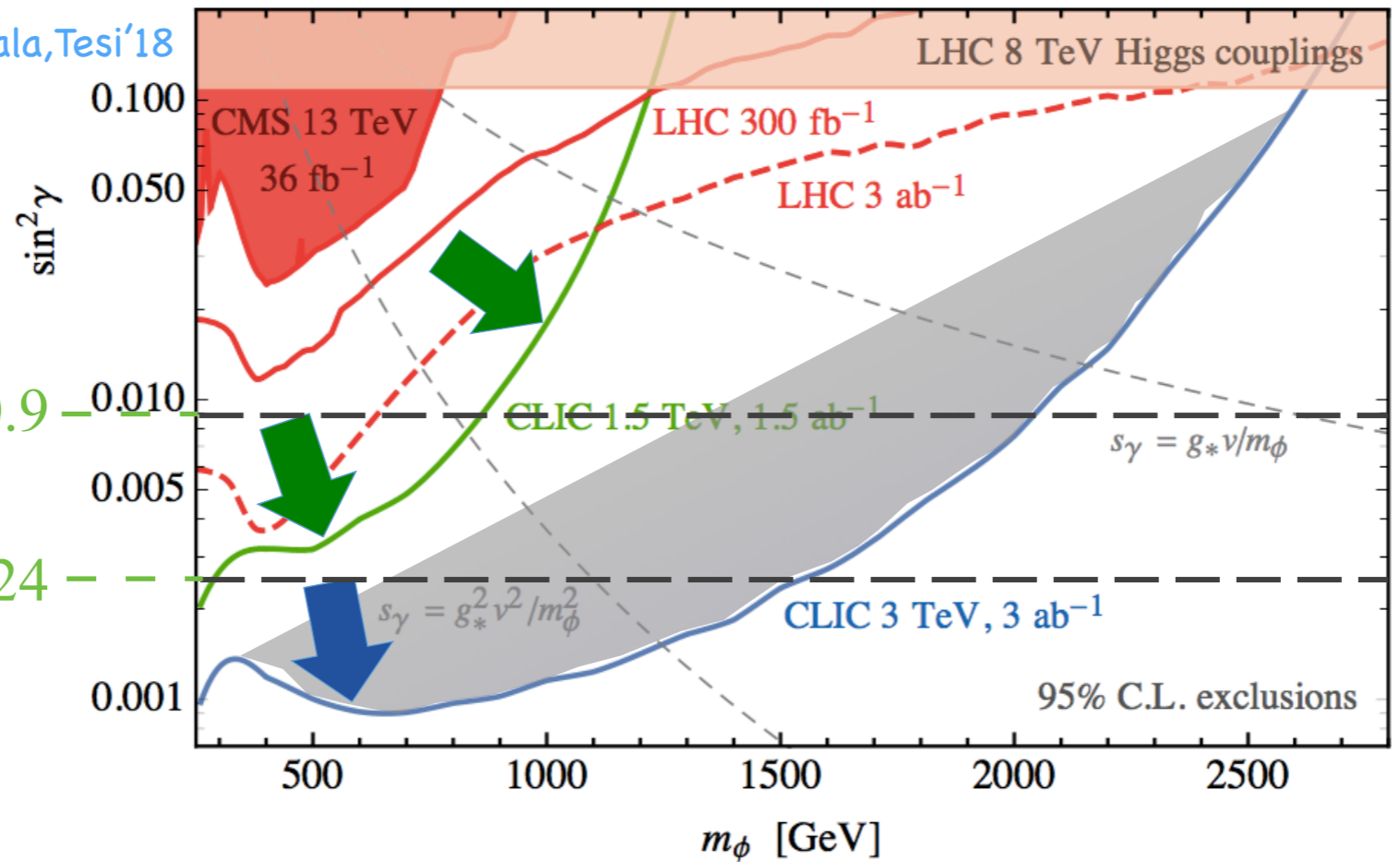

Indirect Searches

CLIC (380)

CLIC (3000)

0.9  
0.024

95% C.L. exclusions

One of the simplest extensions of the Standard Model (SM).

The scalar sector consists of two doublets:

- ▶  $\Phi_S$  is the **SM-like Higgs** doublet,
- ▶  $\Phi_D$  (**inert doublet**) has four additional scalars  $H, A, H^\pm$ .

$$\Phi_S = \begin{pmatrix} G^\pm \\ \frac{v+h+iG^0}{\sqrt{2}} \end{pmatrix} \quad \Phi_D = \begin{pmatrix} H^\pm \\ \frac{H+iA}{\sqrt{2}} \end{pmatrix}$$

We assume a discrete  $Z_2$  symmetry under which

- ▶ SM Higgs doublet  $\Phi_S$  is **even**:  $\Phi_S \rightarrow \Phi_S$  (also other SM  $\rightarrow$  SM)
- ▶ inert doublet  $\Phi_D$  is **odd**:  $\Phi_D \rightarrow -\Phi_D$ .

$\Rightarrow$  Yukawa-type interactions only for Higgs doublet ( $\Phi_S$ ).

The **inert** doublet ( $\Phi_D$ ) **does not interact with the SM fermions!**

$\Rightarrow$  The lightest inert particle is stable: a natural **candidate for dark matter!**

We assume the neutral scalar  $H$  is the dark matter particle.

$$m_H < m_A, m_{H^\pm}$$

Same flavour lepton pair production can be considered a signature of the  $AH$  production process followed by the  $A$  decay:

$$e^+e^- \rightarrow HA \rightarrow HHZ^{(*)} \rightarrow HH\mu^+\mu^-$$

while the production of the different flavour lepton pair is the expected signature for  $H^+H^-$  production:

$$e^+e^- \rightarrow H^+H^- \rightarrow HHW^{+(*)}W^{-(*)} \rightarrow HH\ell^+\ell'^-\nu\bar{\nu}'$$

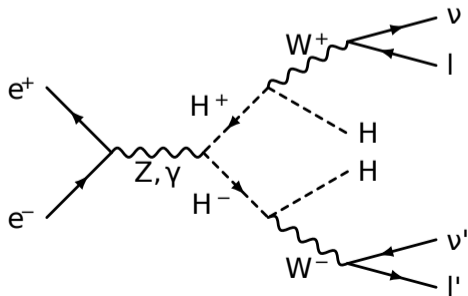
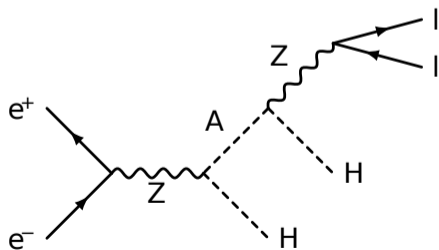



BDT selection and signal significance analysis performed for 41 benchmark scenarios

Results for: 1000 fb<sup>-1</sup> at 380 GeV, 2500 fb<sup>-1</sup> at 1.5 TeV and 5000 fb<sup>-1</sup> at 3 TeV

$AH$  signature ( $\mu^+ \mu^-$ )

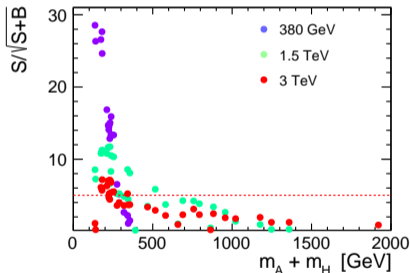

$H^+ H^-$  signature ( $\mu^\pm e^\mp$ )

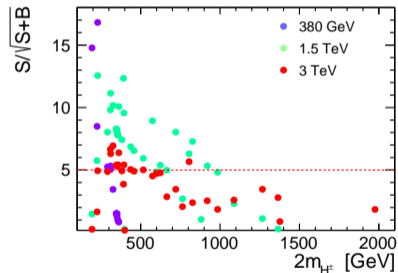

Visible increase in discovery reach for 1.5 TeV:

- ▶ neutral scalar production:  $m_A + m_H < 550$  GeV (290 GeV @ 380 GeV)
- ▶ charged scalar production:  $m_{H^\pm} < 500$  GeV (150 GeV @ 380 GeV)

# Status of the project



## 2013 – 2019

### Development Phase

Development of a project plan for a staged CLIC implementation in line with LHC results; technical developments with industry, performance studies for accelerator parts and systems, detector technology demonstrators

## 2020 – 2025

### Preparation Phase

Finalisation of implementation parameters, preparation for industrial procurement, pre-series and system optimisation studies, technical proposal of the experiment, site authorisation

## 2026 – 2034

### Construction Phase

Construction of the first CLIC accelerator stage compatible with implementation of further stages; construction of the experiment; hardware commissioning



# CLIC reports

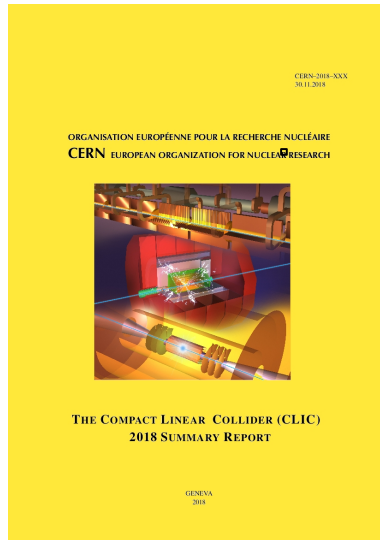

[CERN-2018-005-M](http://dx.doi.org/10.23731/CYRM-2018-002)

<http://dx.doi.org/10.23731/CYRM-2018-002>

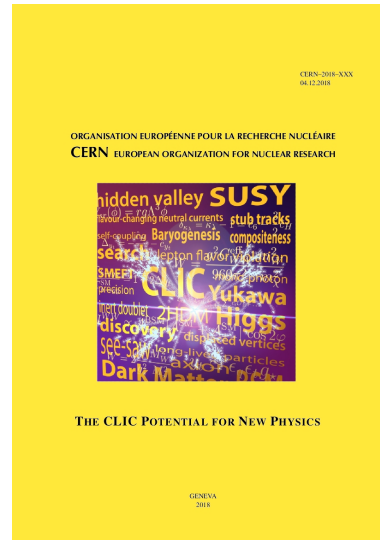

[CERN-2018-009-M](http://dx.doi.org/10.23731/CYRM-2018-003)

<http://dx.doi.org/10.23731/CYRM-2018-003>

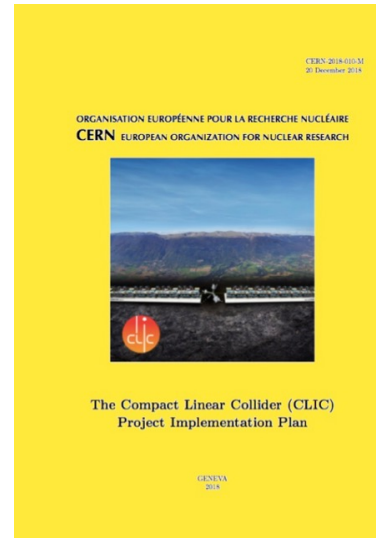

[CERN-2018-010-M](http://dx.doi.org/10.23731/CYRM-2018-004)

<http://dx.doi.org/10.23731/CYRM-2018-004>

The CLIC 2018 Summary Report  
The CLIC Potential for New Physics  
The CLIC Project Implementation Plan

→ all published  
as 2018 CERN Yellow Reports



# CLIC reports



## The Compact Linear $e^+e^-$ Collider (CLIC): Accelerator and Detector

*Input to the European Particle Physics Strategy Update  
on behalf of the CLIC and CLICdp Collaborations*

18 December 2018

Contact person: A. Robson<sup>1,2\*</sup>

Editors: P. N. Burrows<sup>3</sup>, N. Catalan-Latzer<sup>4</sup>, L. Linssen<sup>5</sup>, M. Petráš<sup>6</sup>,

A. Robson<sup>1</sup>, D. Schulte<sup>7</sup>, S. Seidel<sup>8</sup>, S. Stapnes<sup>9</sup>, W. Wernke<sup>10</sup>

<sup>1</sup> CERN, Switzerland, <sup>2</sup> University of Glasgow, United Kingdom, <sup>3</sup> University of Oxford, United Kingdom

### Abstract

The Compact Linear Collider (CLIC) is a TeV-scale high-luminosity linear  $e^+e^-$  collider under development by international collaborations hosted by CERN. This document provides an overview of the design, technology, and implementation aspects of the CLIC accelerator and the detector. For an optimal exploitation of its physics potential, CLIC is foreseen to be built and operated in stages, at centre-of-mass energies of 380 GeV, 1.2 TeV and 3 TeV, for a site length ranging between 11 km and 50 km. CLIC uses a two-beam acceleration scheme, in which normal-conducting high-gradient 12 GHz accelerating structures are powered via a high-current drive beam. For the first stage, an alternative with X-band klystron powering is also considered. CLIC accelerator optimization, technical developments, and system tests have resulted in significant progress in recent years. Moreover, this has led to an increased energy efficiency and reduced power consumption of around 170 MW for the 380 GeV stage, together with a reduced cost estimate of approximately 6 billion CHF. The detector concept, which matches the physics performance requirements and the CLIC experimental conditions, has been refined using improved software tools for simulation and reconstruction. Significant progress has been made on detector technology developments for the tracking and calorimetry systems. The construction of the first CLIC energy stage could start as early as 2026 and first beams would be available by 2035, marking the beginning of a physics programme spanning 25–30 years and providing excellent sensitivity to Beyond Standard Model physics, through direct searches and via a broad set of precision measurements of Standard Model processes, particularly in the Higgs and top-quark sectors.

© 2018 CERN for the benefit of the CLIC and CLICdp Collaborations.  
Reproduction of this article or parts of it is allowed as specified in the CC-BY 4.0 license.

\*aidan.robson@cern.ch



## The Compact Linear $e^+e^-$ Collider (CLIC): Physics Potential

*Input to the European Particle Physics Strategy Update  
on behalf of the CLIC and CLICdp Collaborations*

18 December 2018

Contact person: P. Roloff<sup>1,2\*</sup>

Editors: R. Franceschini<sup>3</sup>, P. Roloff<sup>1,2</sup>, U. Schwoos<sup>4</sup>, A. Weiler<sup>5,6</sup>

<sup>1</sup> CERN, Geneva, Switzerland, <sup>2</sup> Università degli Studi Roma Tre, Rome, Italy, <sup>3</sup> INFN, Sezione di Roma Tre, Rome, Italy, <sup>4</sup> Università di Padova, Padova, Italy, <sup>5</sup> EPFL, EPFL, Lausanne, Switzerland

### Abstract

The Compact Linear Collider, CLIC, is a proposed  $e^+e^-$  collider at the TeV scale whose physics potential ranges from high-precision measurements to extensive direct sensitivity to physics beyond the Standard Model. This document summarises the physics potential of CLIC, obtained in detailed studies, many based on full simulation of the CLIC detector. CLIC covers one order of magnitude of centre-of-mass energies from 380 GeV to 3 TeV, giving access to large event samples for a variety of SM processes, many of them for the first time in  $e^+e^-$  collisions or for the first time at all. The high collision energy combined with the large luminosity and clean environment of the  $e^+e^-$  collisions enables the measurement of the properties of Standard Model particles, such as the Higgs boson and the top quark, with unparalleled precision. CLIC might also discover indirect effects of very heavy new physics by probing the parameters of the Standard Model Effective Field Theory with an unprecedented level of precision. The direct and indirect reach of CLIC to physics beyond the Standard Model significantly exceeds that of the HL-LHC. This includes new particles detected in challenging non-standard signatures. With this physics programme, CLIC will decisively advance our knowledge relating to the open questions of particle physics.

© 2018 CERN for the benefit of the CLIC and CLICdp Collaborations.  
Reproduction of this article or parts of it is allowed as specified in the CC-BY 4.0 license.

\*p.roloff@cern.ch

# Two formal European Strategy Update submissions made on 18<sup>th</sup> December



# CLIC schedule: TDR 2025, start construction 2026

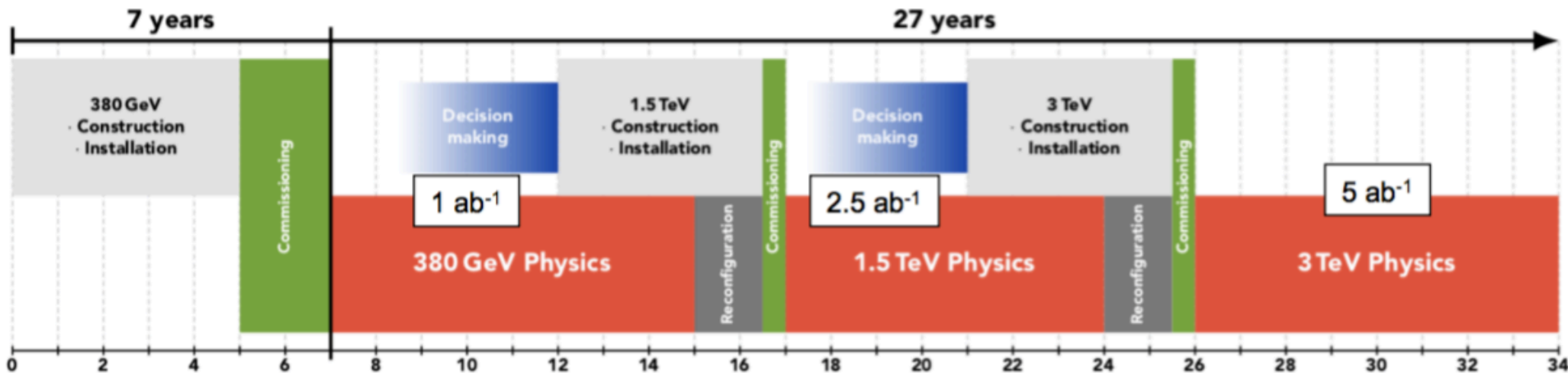

Cost of stage 1: CHF 5.9B  
stage 2: + CHF 5.1B  
stage 3: + CHF 7.3B



# FCC cost and schedule (from DG's new year message)

**Purely technical** schedule, assuming green light to preparation work in 2020.  
**A 70 years programme**

8 years preparation	10 years tunnel and FCC-ee construction	15 years FCC-ee operation	11 years FCC-hh preparation and installation	25 years FCC-hh operation pp/PbPb/eh
2020-2028		2038-2053		2064-2090

FCC-ee

Estimated cost: ~ **11.6 BCHF**: 5.4 B (tunnel), 5.1 B (injectors + collider up to  $\sqrt{s}=240$  GeV), 1.1 B (additional RF for operation at  $\sqrt{s} \sim 365$  GeV)

FCC-hh

Estimated cost: ~ **17 BCHF** (13.6 B collider [magnets!] + injectors) if built after FCC-ee (tunnel and part of infrastructure exists); 24 BCHF if standalone.

# The CLIC project

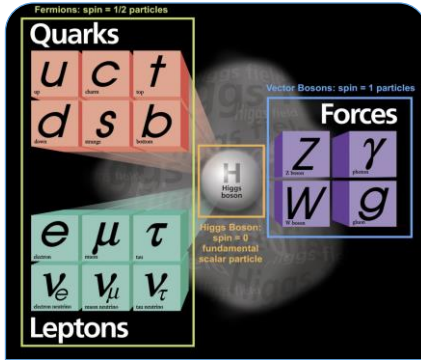

Physics case

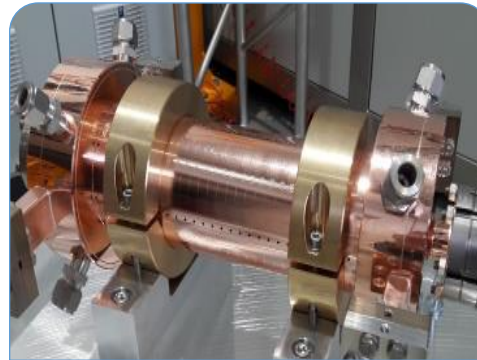

Technical implementation and solutions

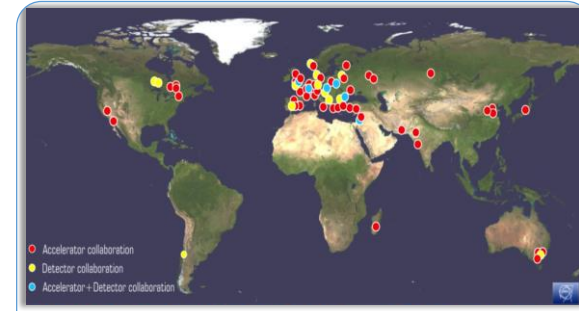

Organization and community

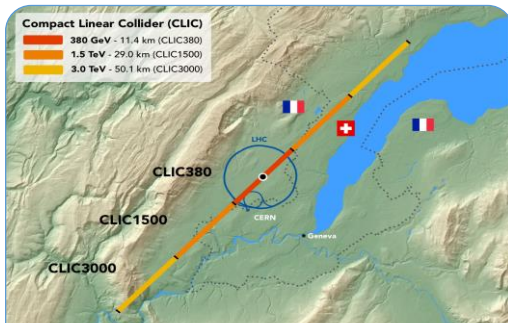

Industrial basis and future flexibility



For any next machine the largest challenges are the cost and timescales/size involved ....

Key activities for a CLIC TDR in the Preparation Phase will be:

1. Prepare technically for industrial production (examples for cost and power drivers on next slide)
2. Pursue large systems tests (not necessarily at CERN)
3. Final design/parameters, cost/power, schedules, CE/site/infrastructure



Thank you!



# Resources



Compact Linear Collider Portal

<http://clic.cern/>



CLIC input to the European Strategy for Particle Physics Update 2018-2020

<http://clic.cern/european-strategy>



CLICdp Publications on CERN Document Server

[https://cds.cern.ch/collection/CLIC Detector and Physics Study](https://cds.cern.ch/collection/CLIC%20Detector%20and%20Physics%20Study)